

ORLANDO 22



Narzędzia potrzebne do montażu



UWAGA !!!

MONTOWANIE USZKODZONYCH
ELEMENTÓW POWODUJE UTRATĘ
GWARANCJI

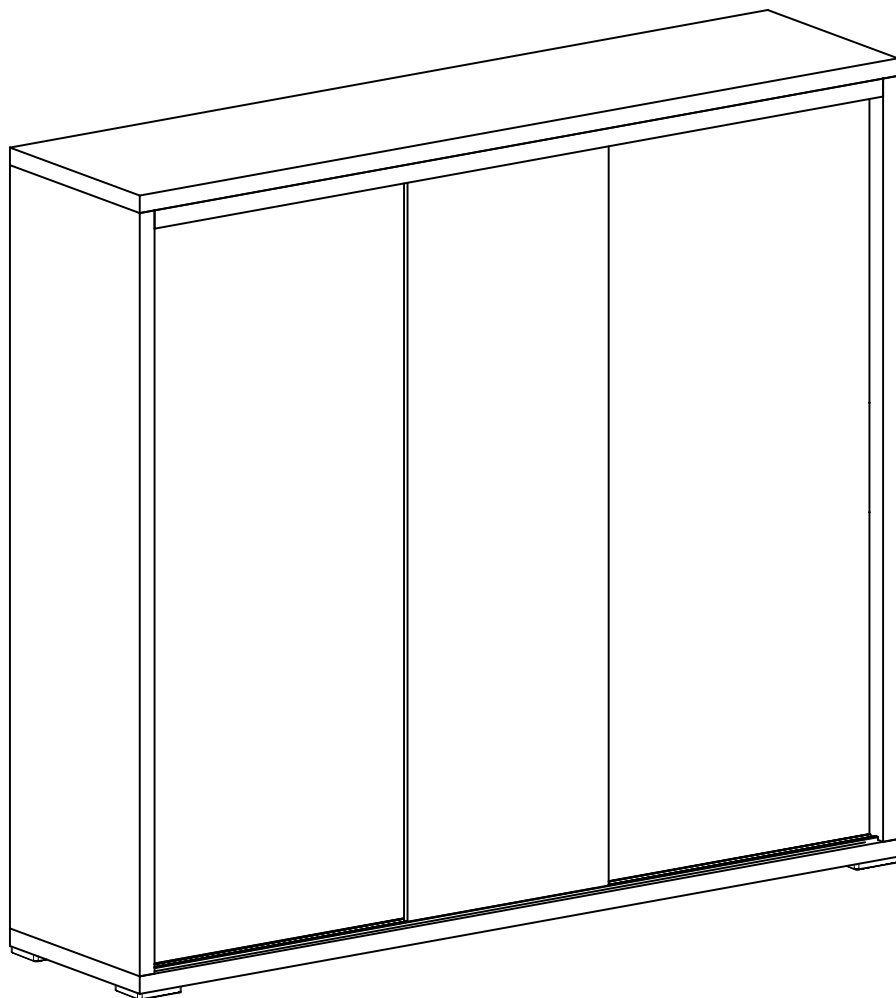

| Nr | D[mm] | S[mm] | G[mm] | Ilość |
|----|-------|-------|-------|-------|
| 1 | 2450 | 600 | 48 | 1 |
| 2 | 2450 | 600 | 48 | 1 |
| 3 | 2090 | 600 | 48 | 1 |
| 4 | 2090 | 460 | 16 | 1 |
| 5 | 2090 | 460 | 16 | 1 |
| 6 | 2090 | 600 | 48 | 1 |
| 7 | 687 | 450 | 16 | 1 |
| 8 | 687 | 450 | 16 | 3 |
| 9 | 848 | 450 | 16 | 2 |
| 10 | 2120 | 868 | 2,5 | 2 |
| 11 | 2120 | 702 | 2,5 | 1 |
| 12 | 2352 | 55 | 16 | 1 |
| 13 | 2050 | 800 | 16 | 1 |
| 14 | 2050 | 800 | 16 | 1 |
| 15 | 2050 | 800 | 16 | 1 |

W przypadku reklamacji proszę podać numer pakowacza znajdujący się na kartonie.

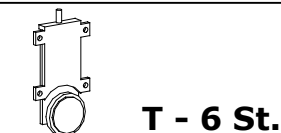
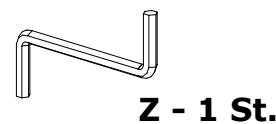
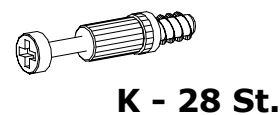
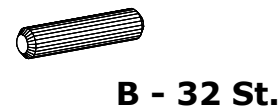
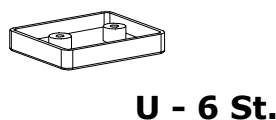
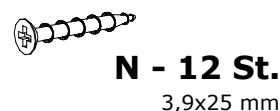
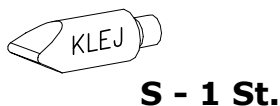
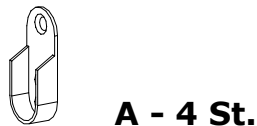
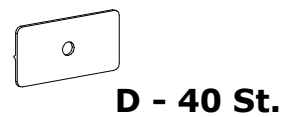
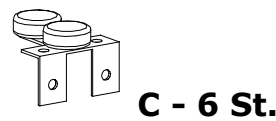
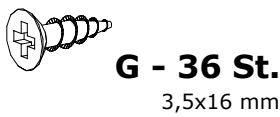
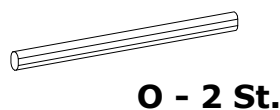
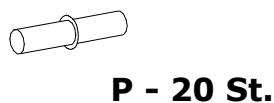
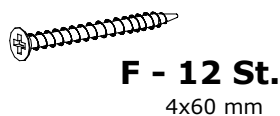
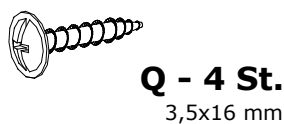
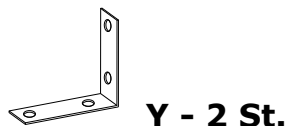

I

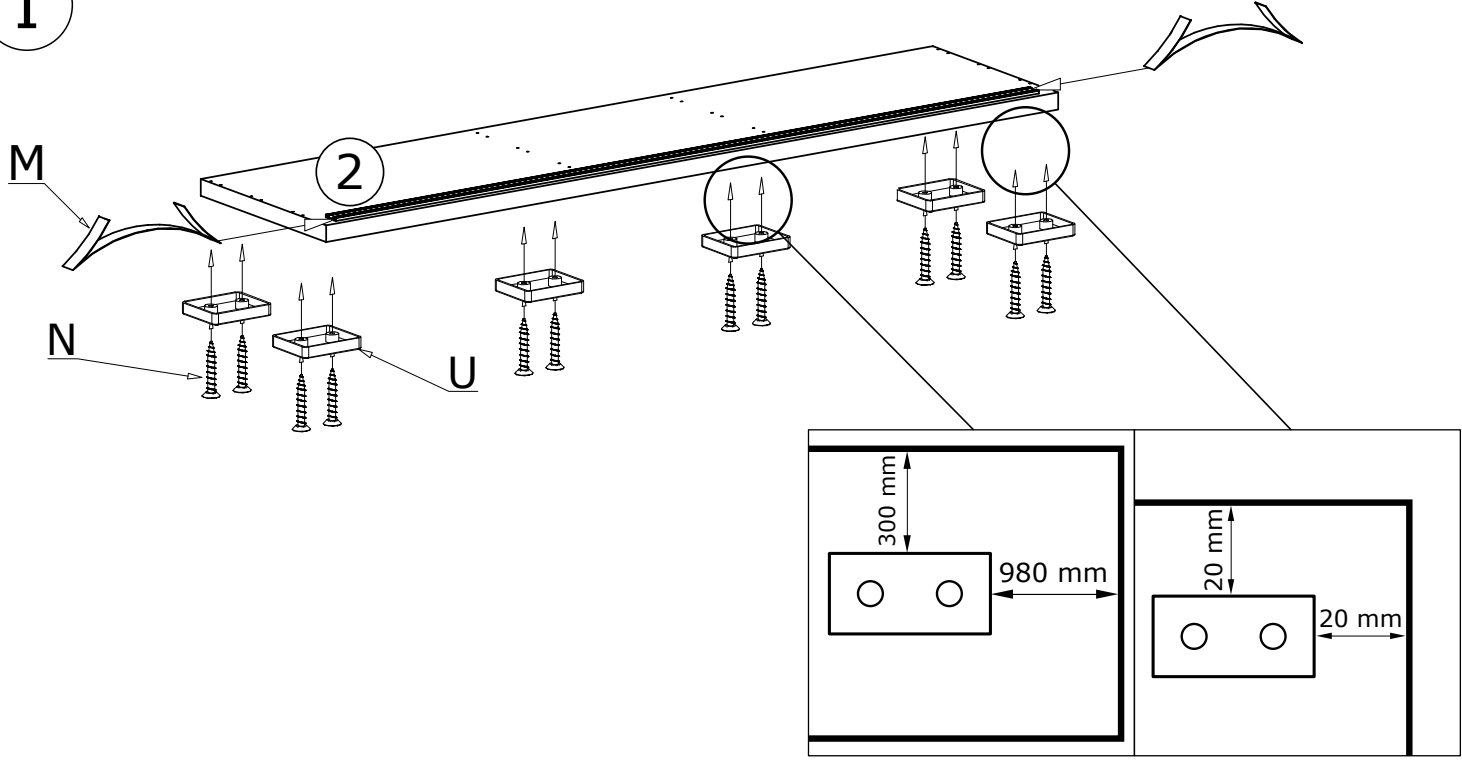

II

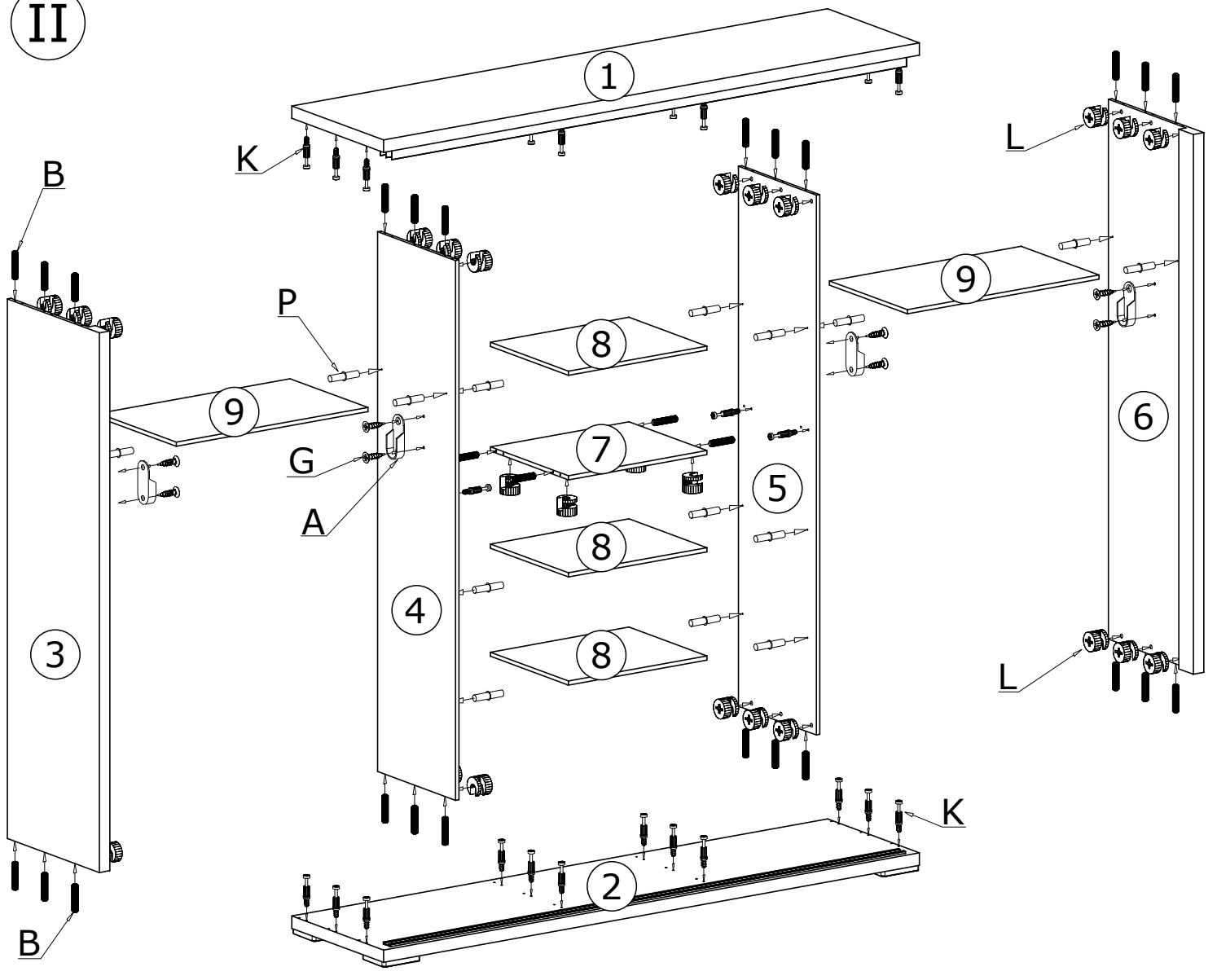

III

130X 

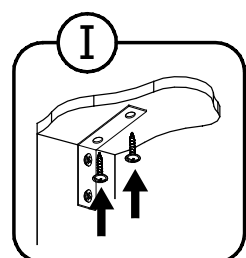
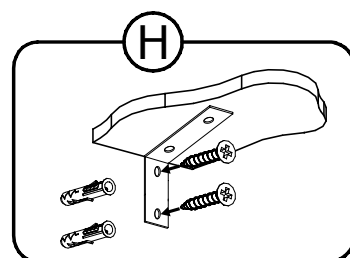
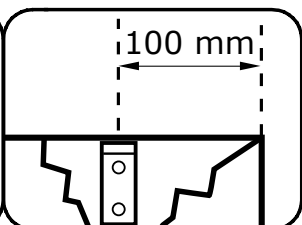
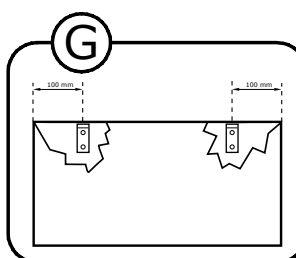
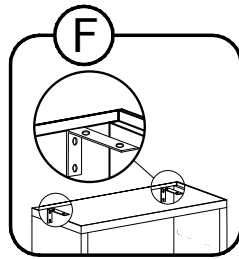
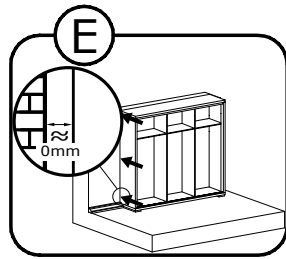
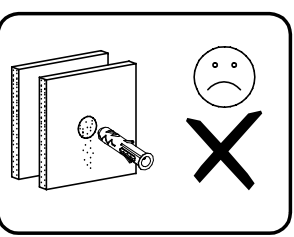
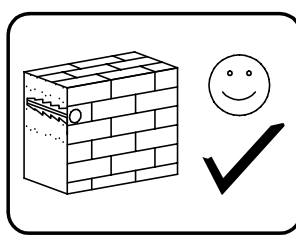
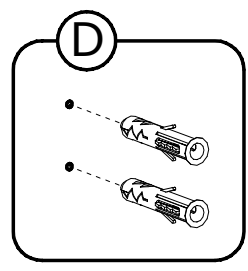
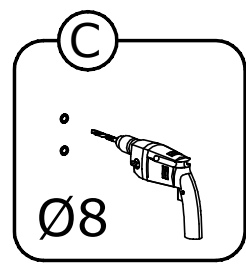
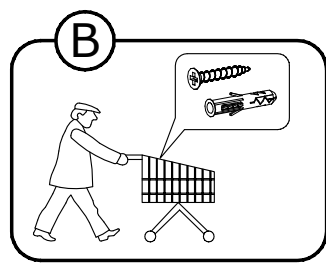
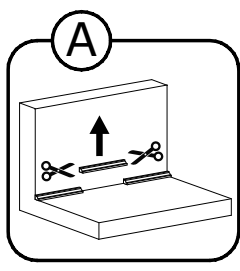
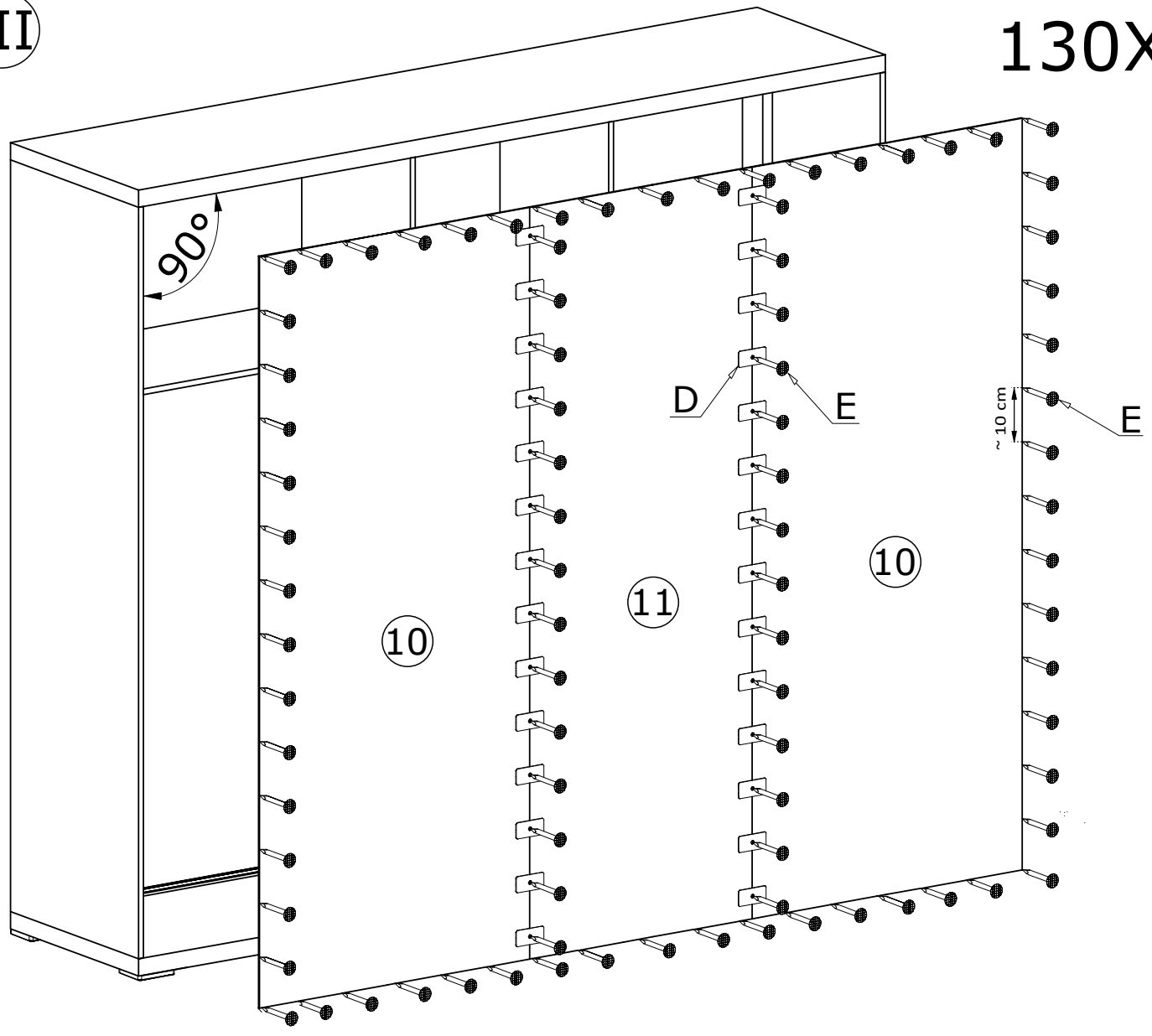

IV

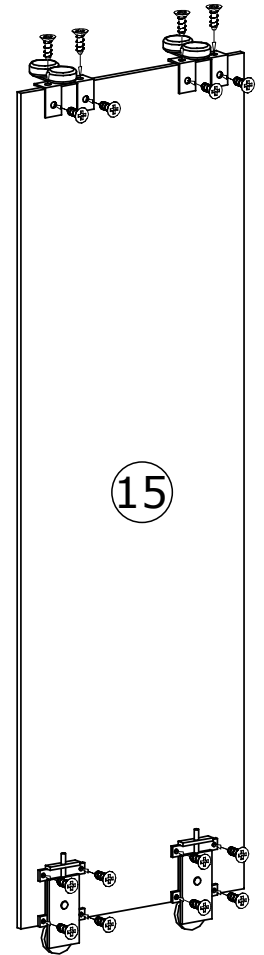
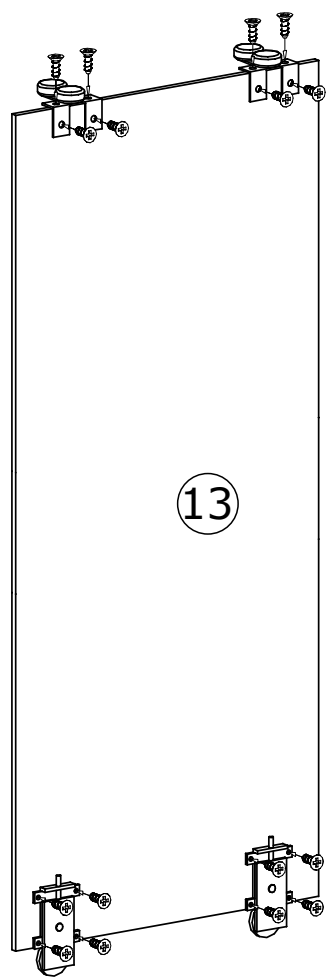
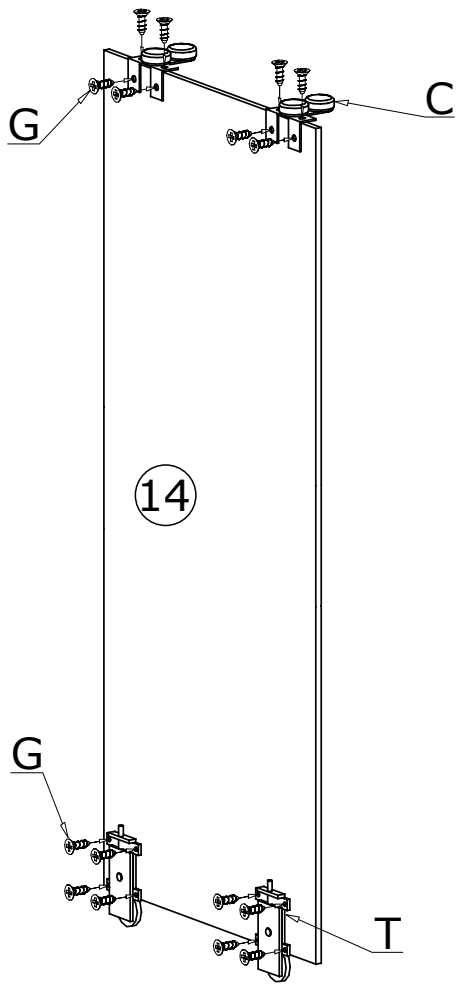

V

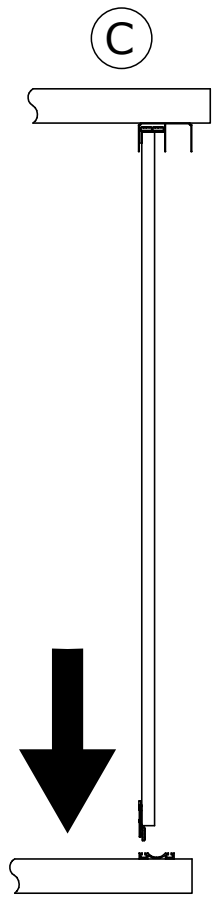
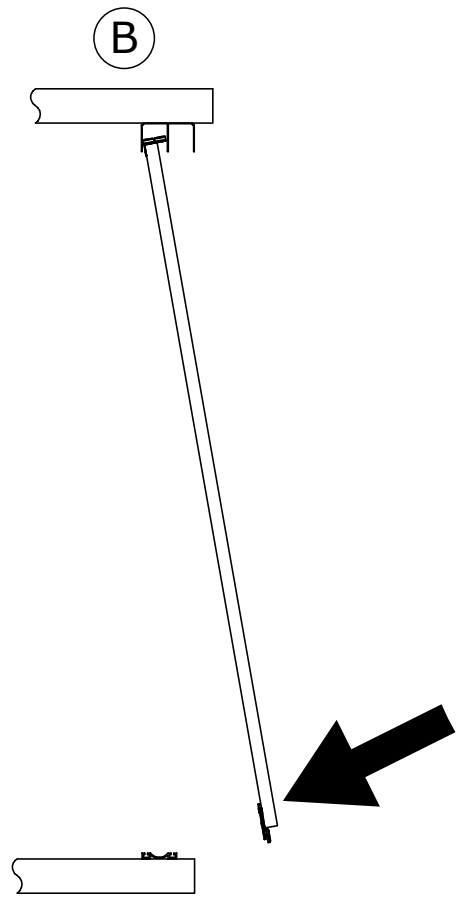
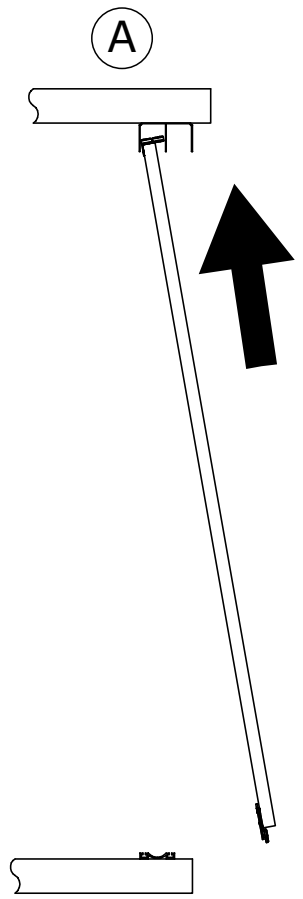

VI

