

# VEGAS 3

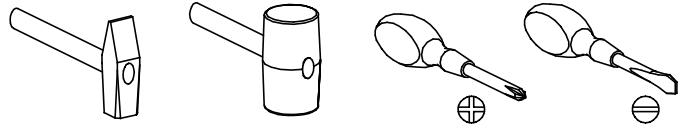

Narzędzia potrzebne do montażu



## UWAGA !!!

MONTOWANIE USZKODZONYCH  
ELEMENTÓW POWODUJE UTRATĘ  
GWARANCJI

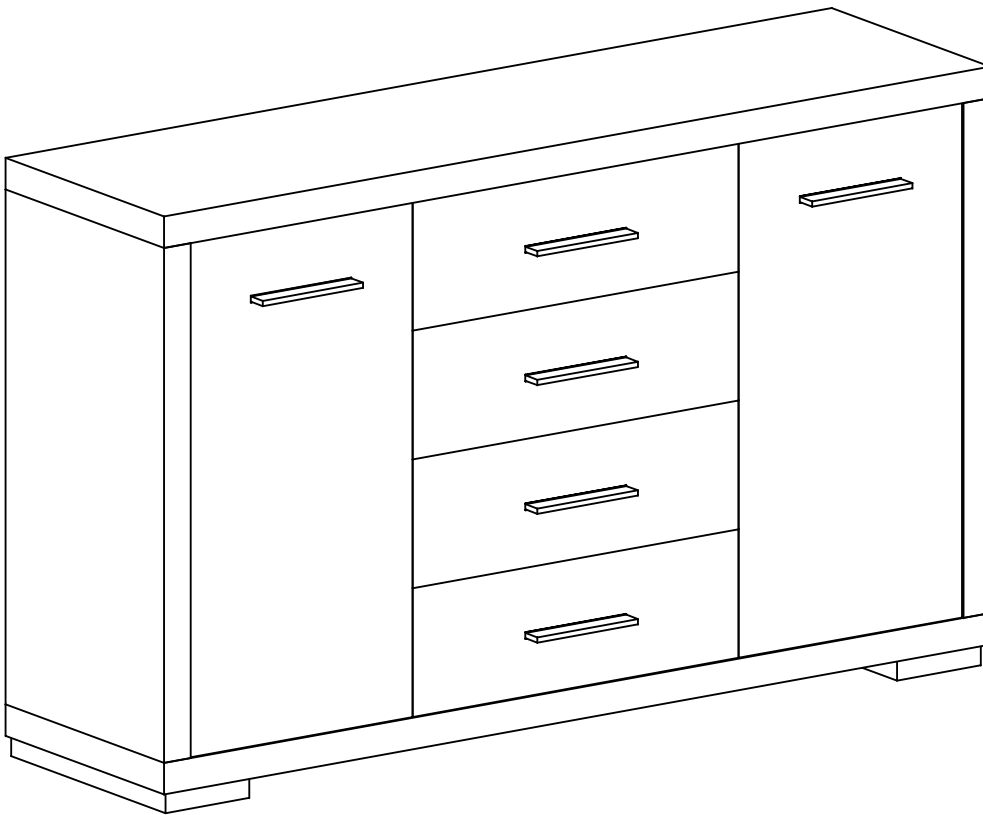

Nr	D[mm]	S[mm]	G[mm]	Ilość
1	1483	407	48	1
2	1483	407	48	1
3	780	405	48	1
4	780	388	16	1
5	780	388	16	1
6	780	405	48	1
7	398	320	16	2
8	1470	834	2,5	1
9	773	368	16	1
10	773	368	16	1
11	590	355	2,5	4
12	635	190	16	4
13	350	165	16	4
14	350	165	16	4
15	559	165	16	4

W przypadku reklamacji proszę podać numer pakowacza znajdujący się na kartonie.

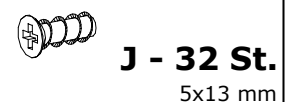
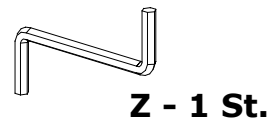
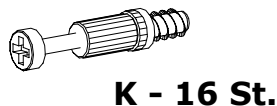
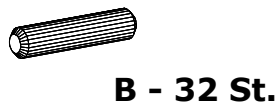
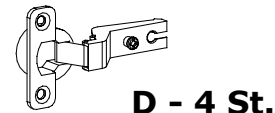
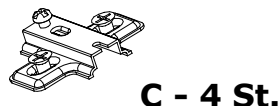
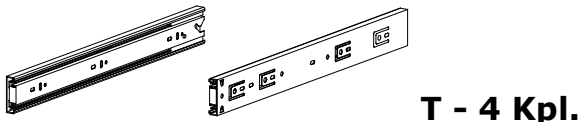
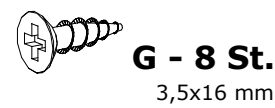
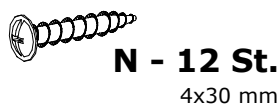
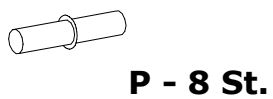
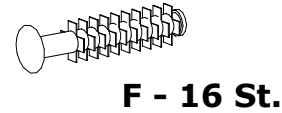
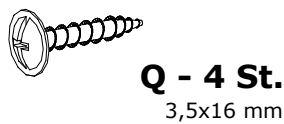
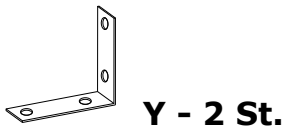

I

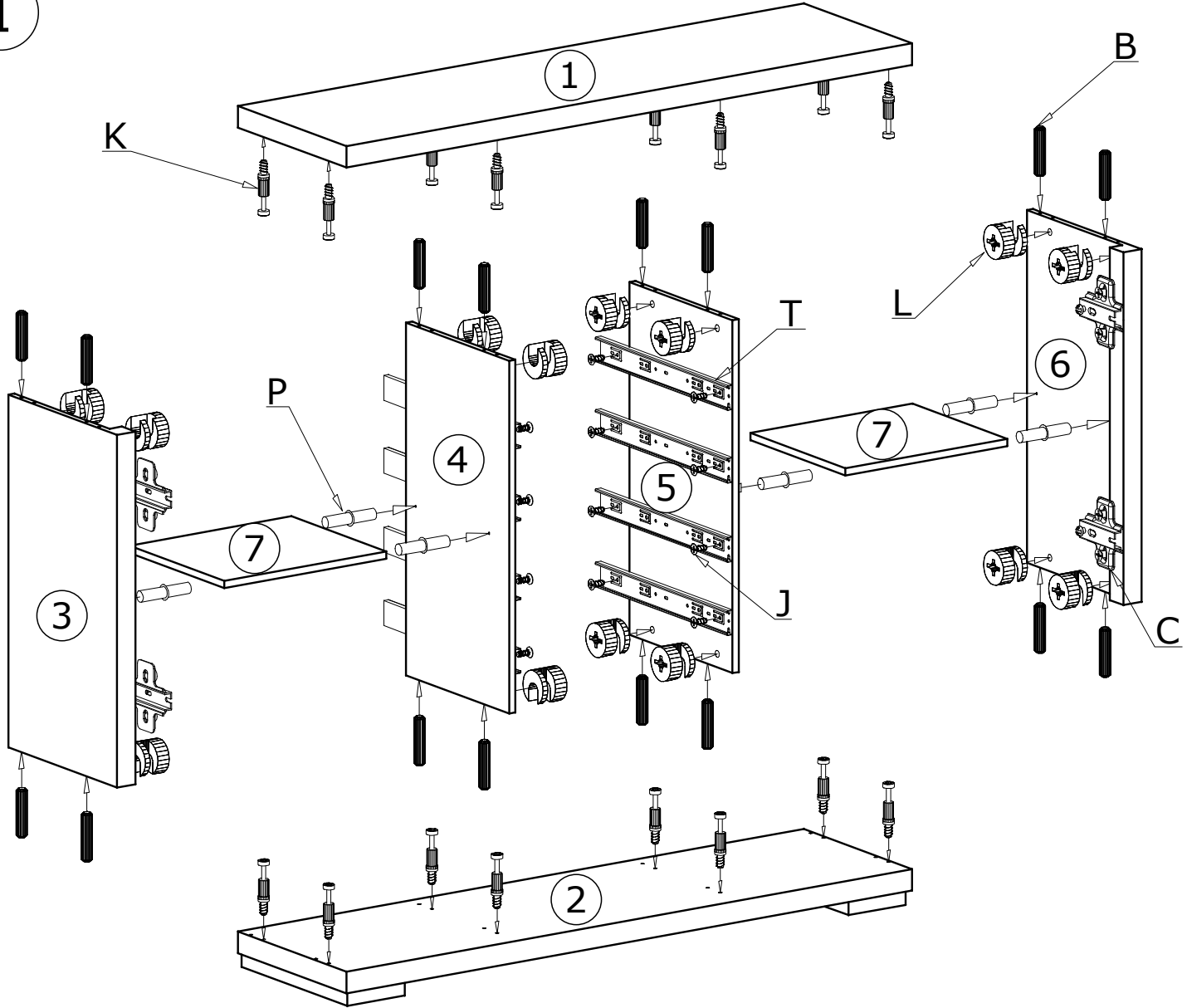

II

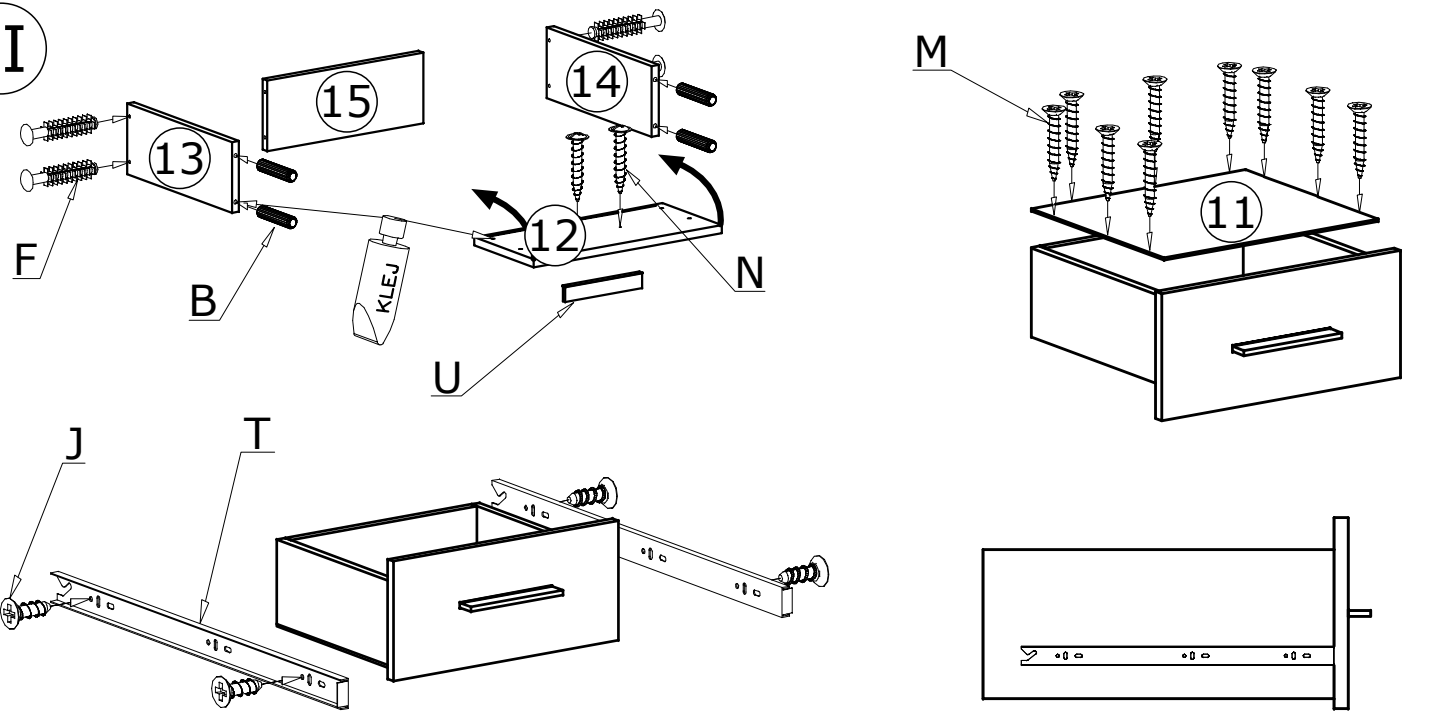

III

50X 

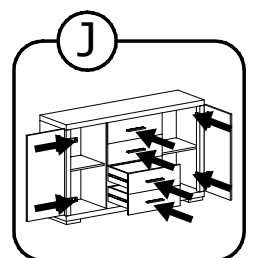
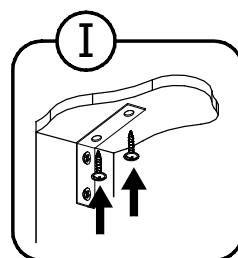
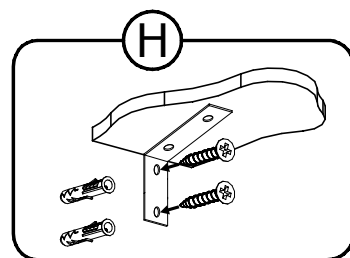
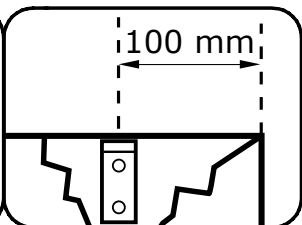
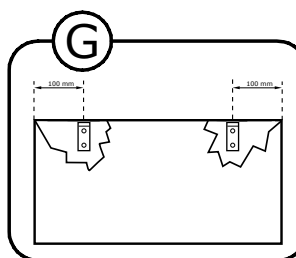
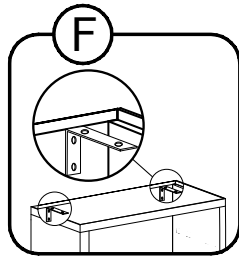
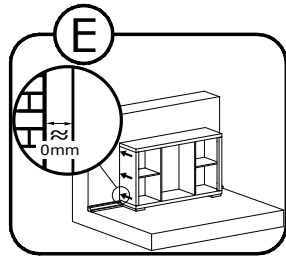
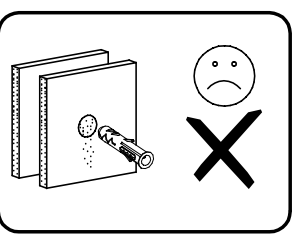
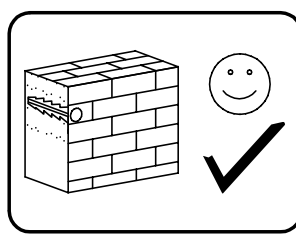
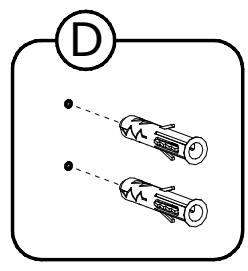
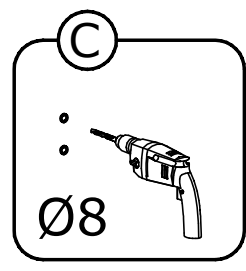
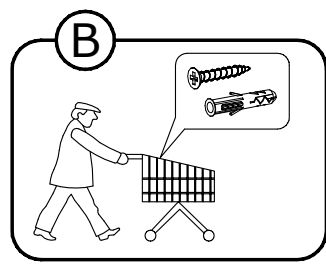
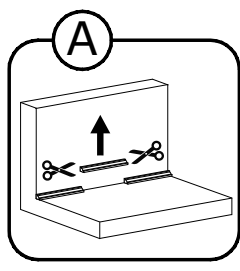
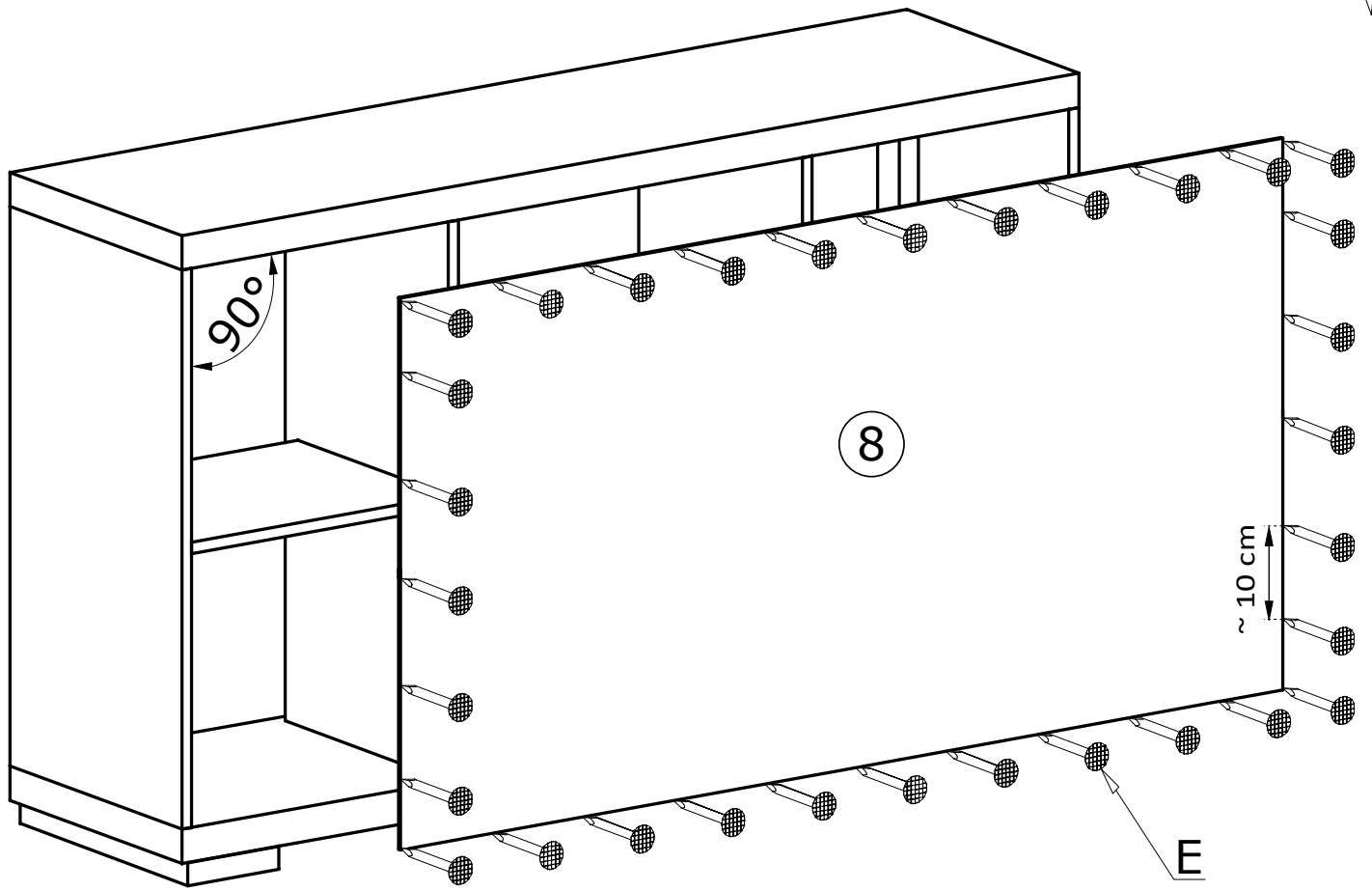

IV

