

# MEDIOLAN 2

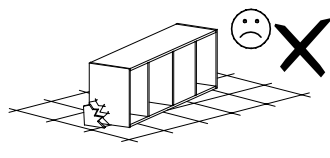

Narzędzia potrzebne do montażu

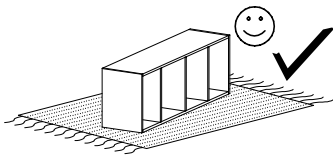
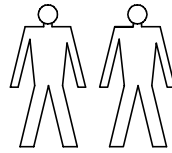
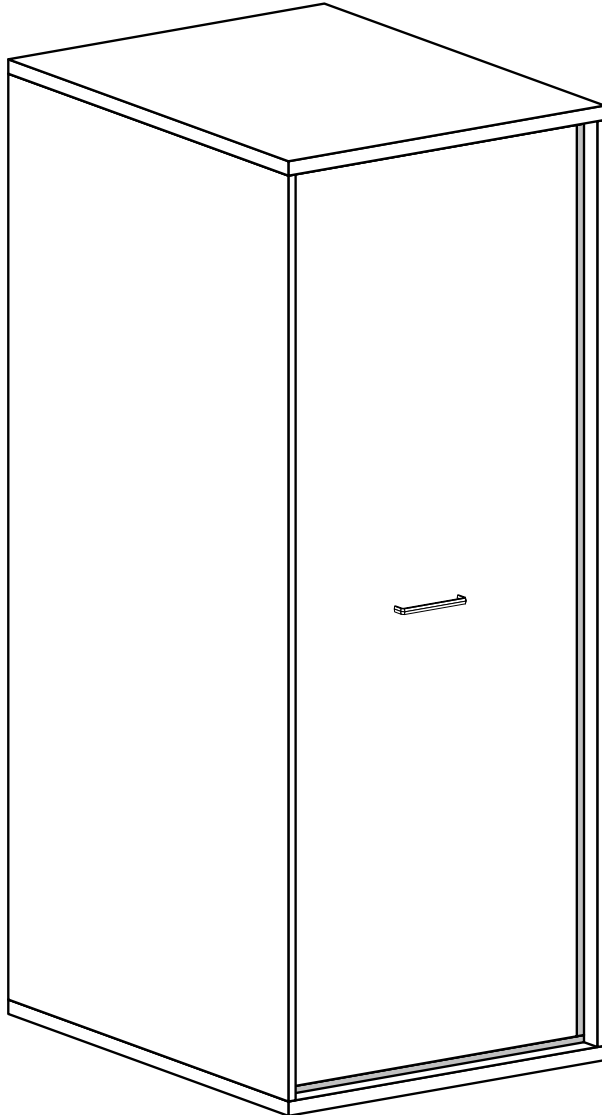
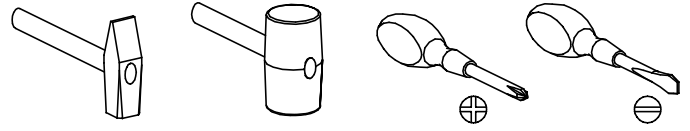

Nr	Nazwa elementu	D[mm]	S[mm]	G[mm]	Ilość
1	Bok P/L	1897	580	16	2
2	Błat Górny	581	495	32	1
3	Błat Dolny	581	495	32	1
4	Wieniec	542	462	16	1
5	Listwa Czarna	1897	20	16	2
6	Listwa Czarna	429	20	16	2
7	Kapak	1940	490	2,5	1
8	Drzwi	1856	422	16	1

**UWAGA !!!**  
 MONTOWANIE USZKODZONYCH  
 ELEMENTÓW POWODUJE UTRATĘ  
 GWARANCJI

**UWAGA !!!**  
 Mebel zawiera  
 elementy drewniane

W przypadku reklamacji proszę podać numer pakowacza znajdujący się na kartonie.

 <b>A - 1 St.</b>	 <b>B - 1 St.</b>	 <b>Y1 - 2 St.</b>	 <b>Y2 - 4 St.</b> 4x25 mm	 <b>X1 - 16 St.</b>
 <b>C - 2 St.</b> 4x25 mm	 <b>D - 20 St.</b> 3,5x16 mm	 <b>E - 16 St.</b>	 <b>F - 16 St.</b>	 <b>G - 16 St.</b>
 <b>H - 2 St.</b>	 <b>I - 50 St.</b>	 <b>J - 4 St.</b>	 <b>K - 3 St.</b>	 <b>L - 1 St.</b>
 <b>M1 - 3 St.</b>	 <b>M2 - 1 St.</b>	 <b>N - 8 St.</b>	 <b>O - 1 St.</b>	 <b>P - 8 St.</b> 6x30 mm

I L

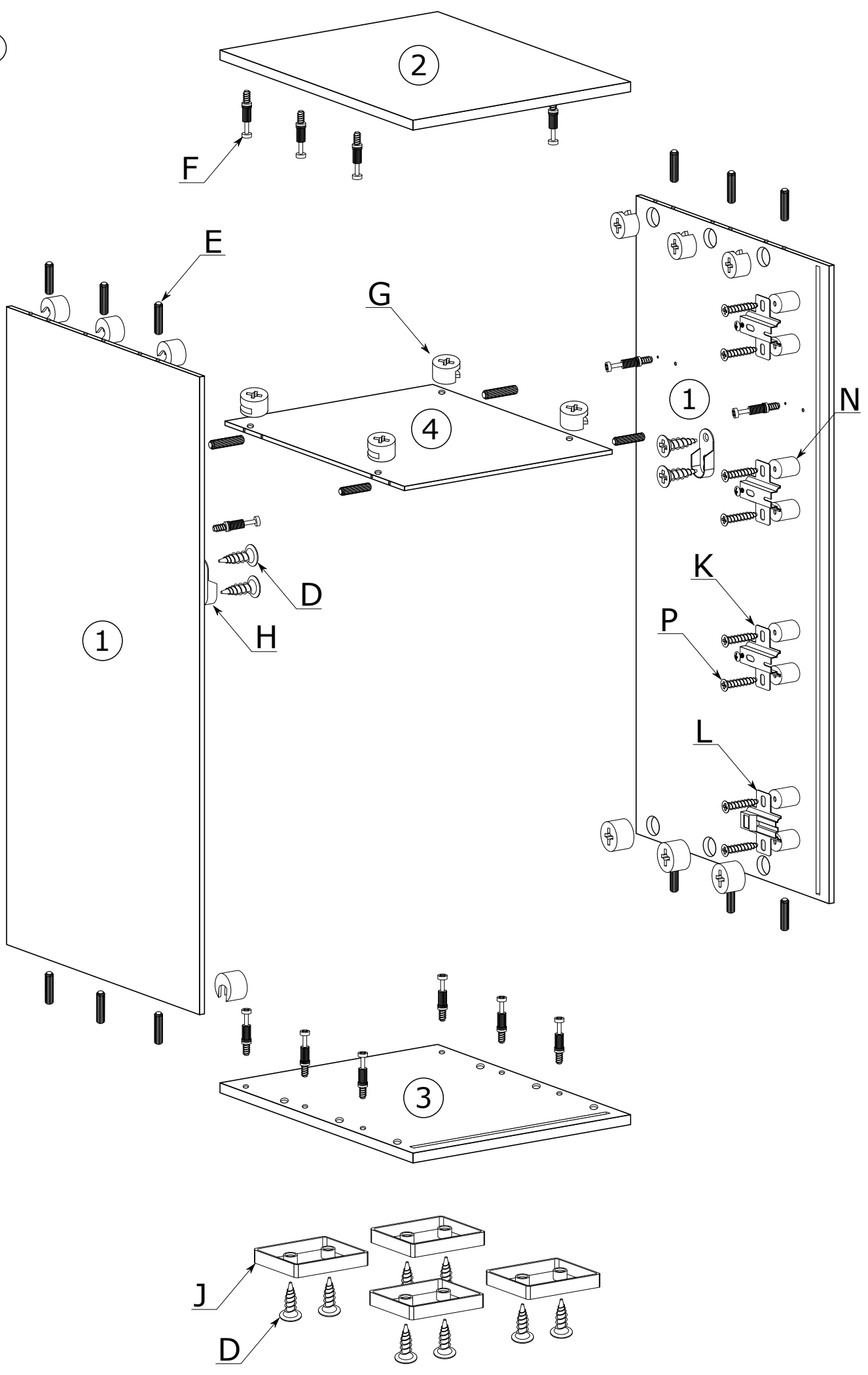

I P

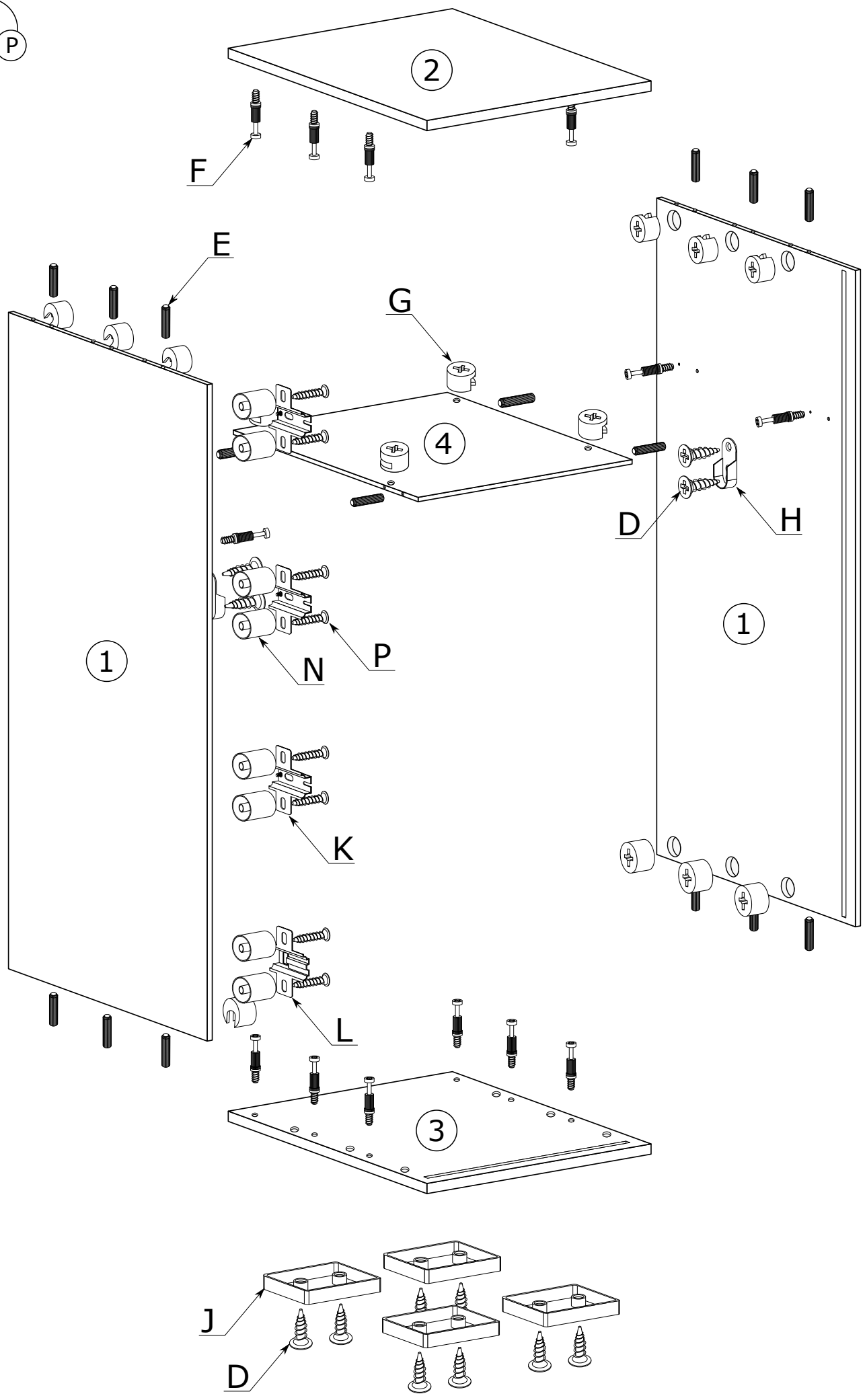

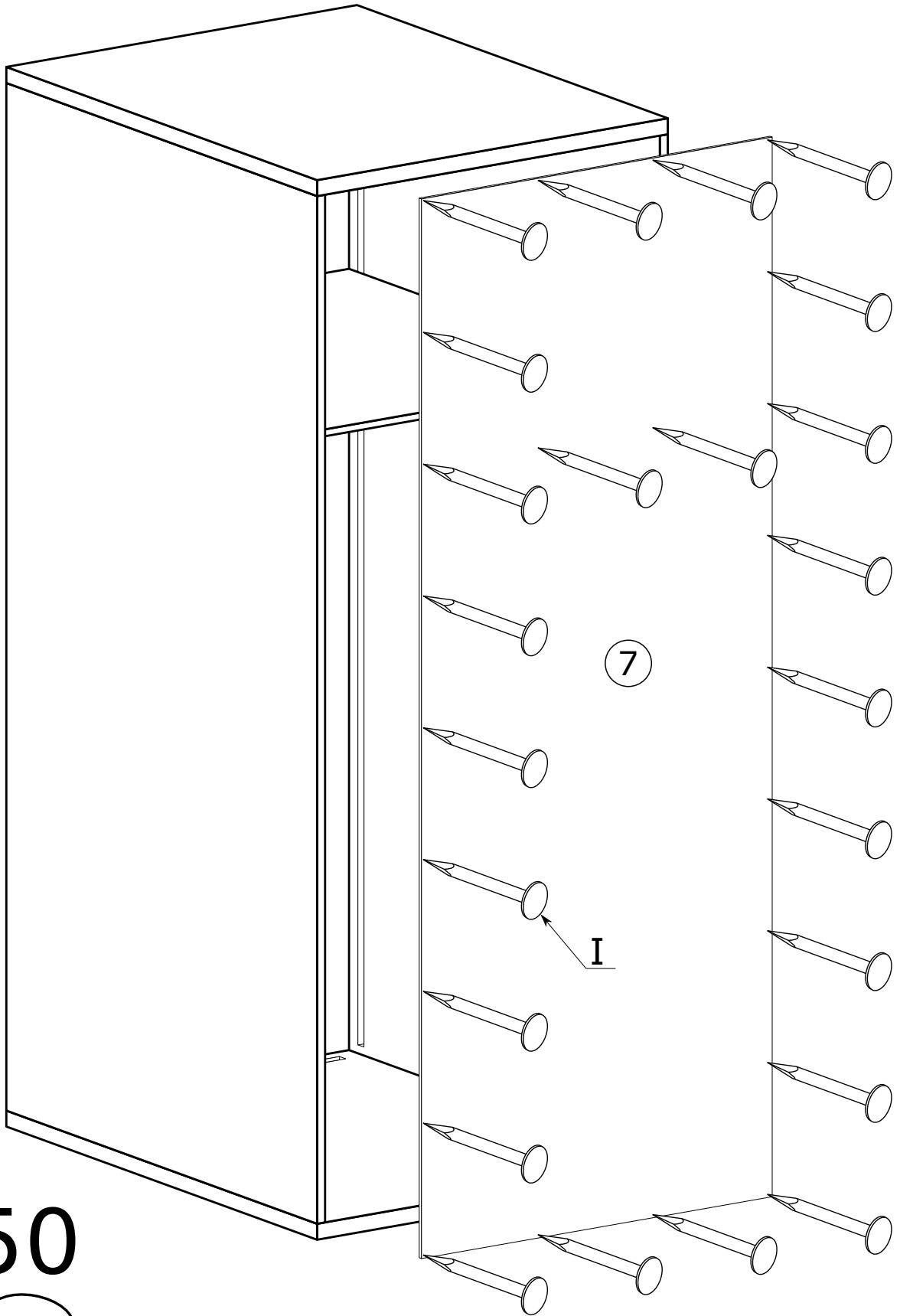

II

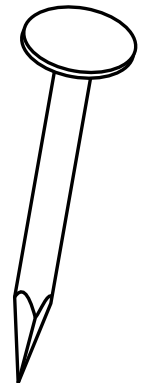

x50

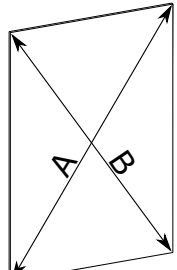

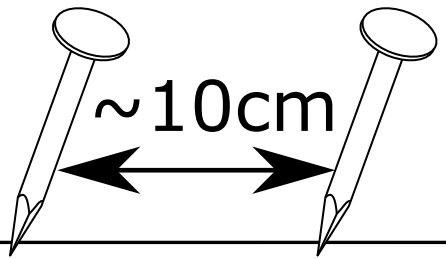
		
$A = B$		$\sim 10\text{cm}$

III

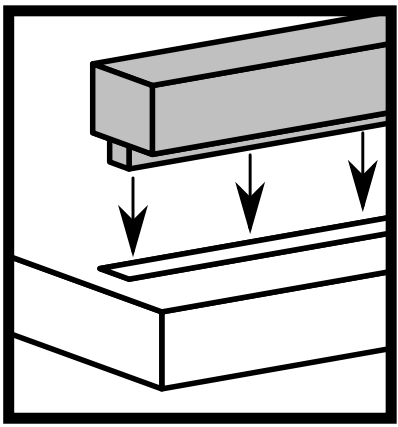
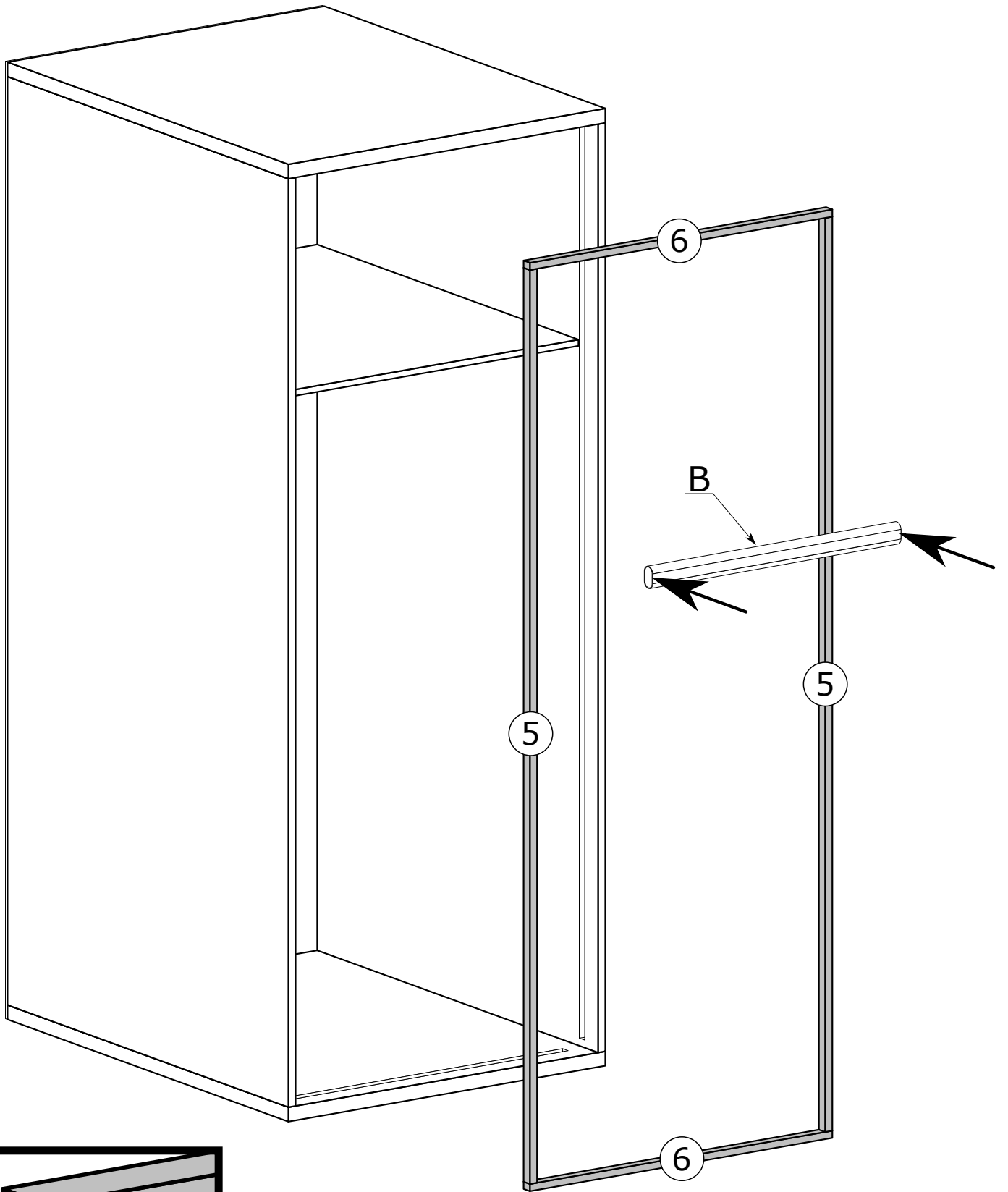

IV

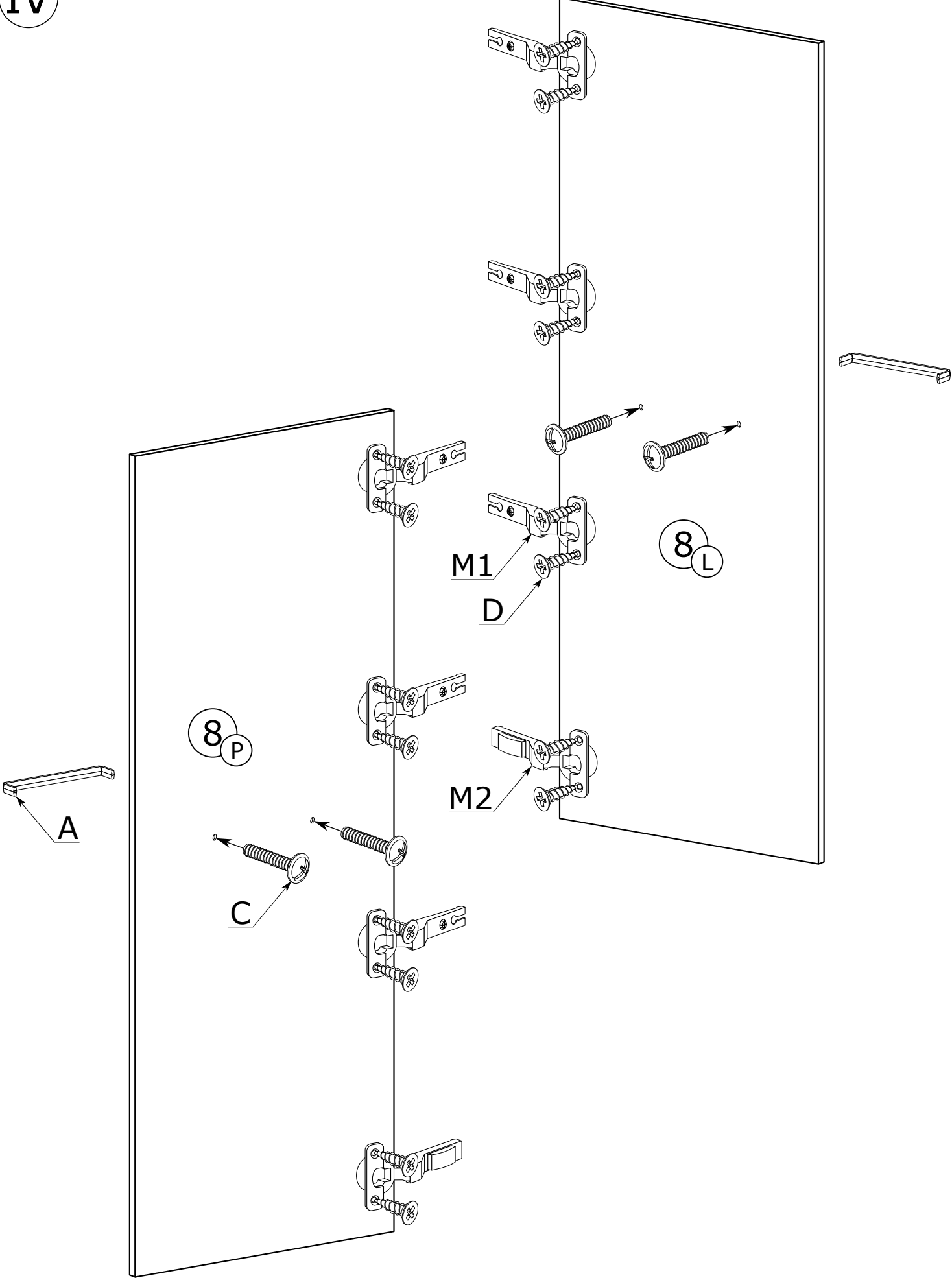

V

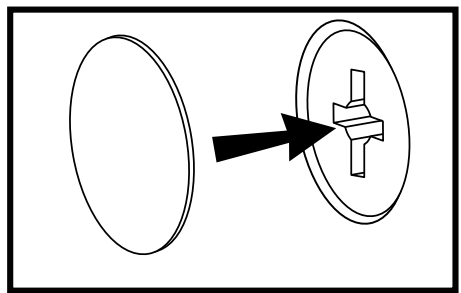
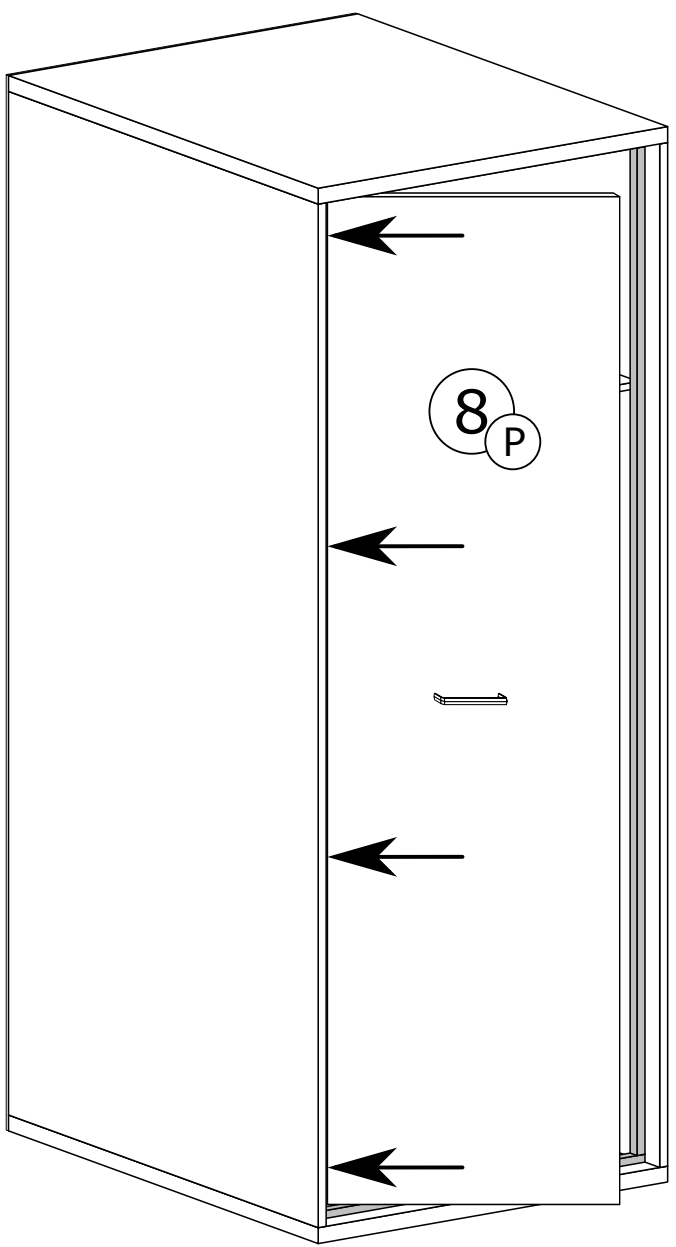
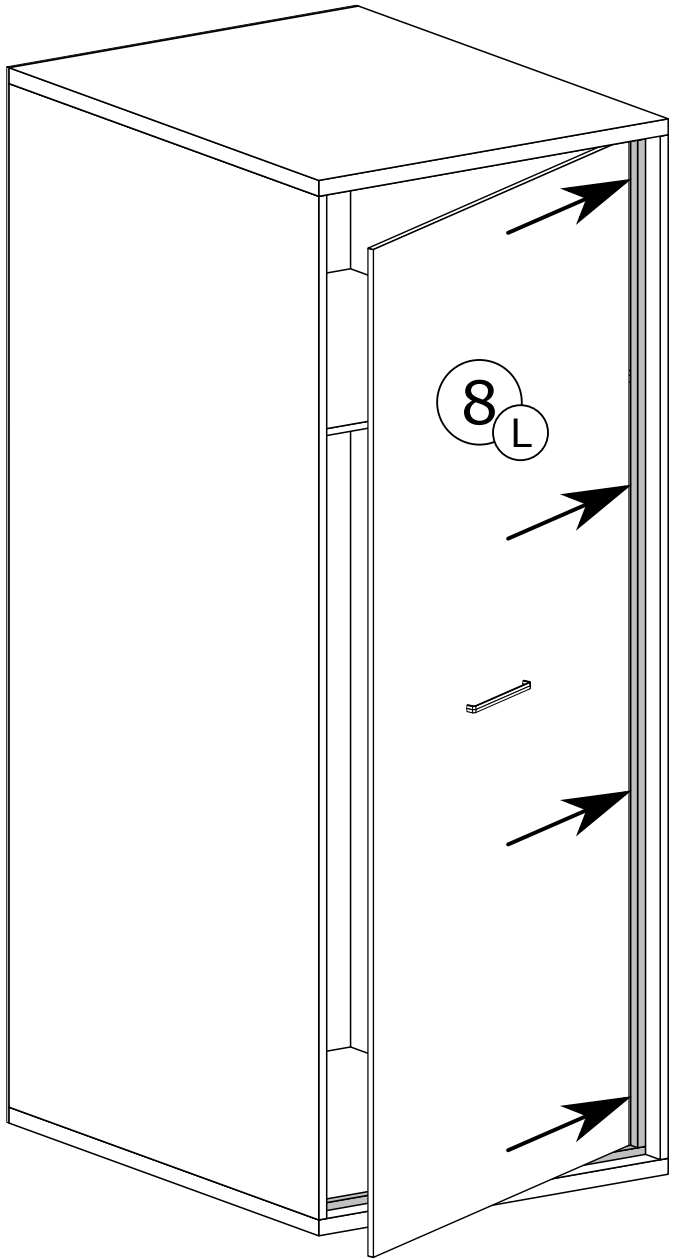

A

