

STÓŁ

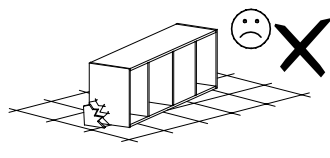

Narzędzia potrzebne do montażu

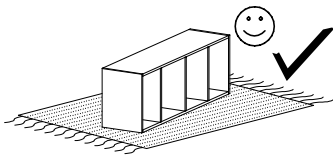
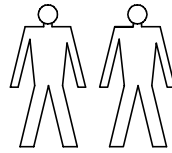
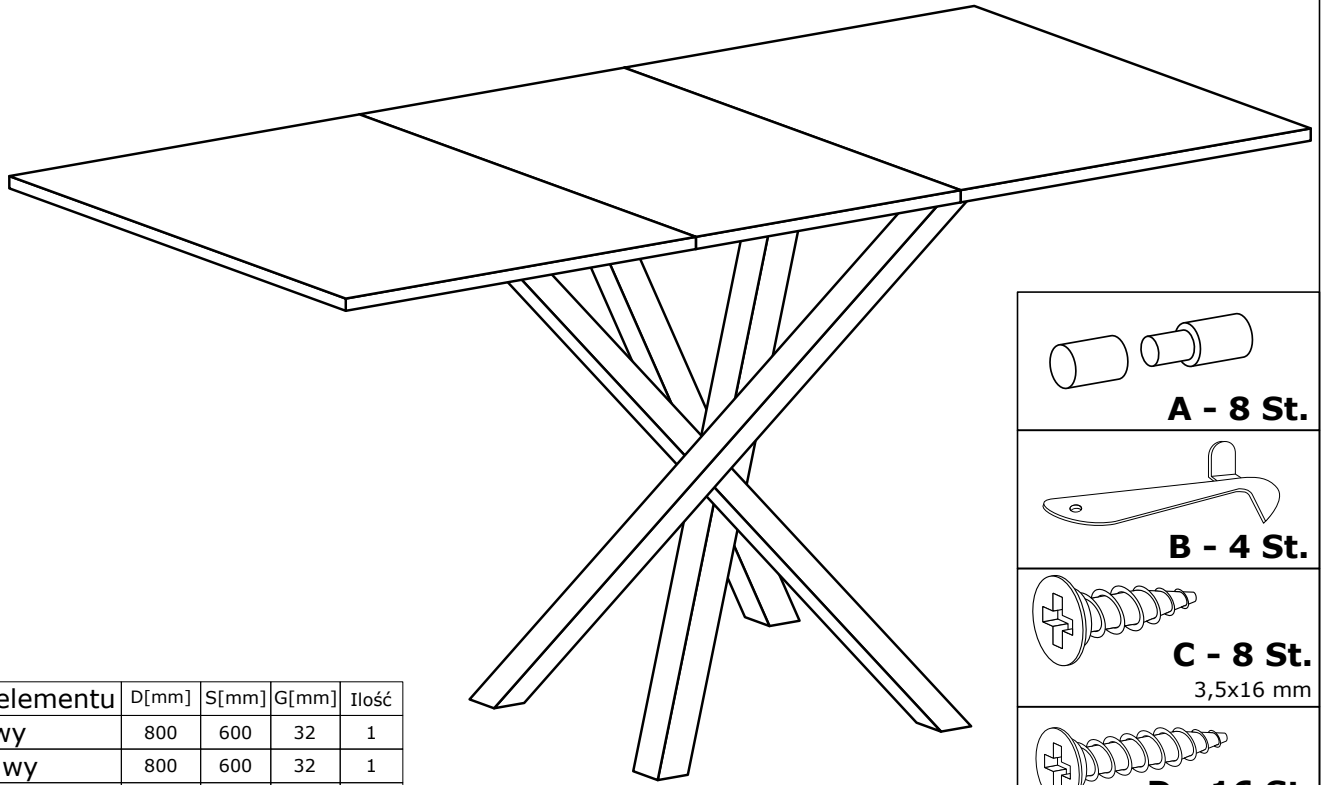
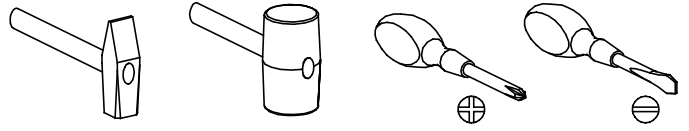

Nr	Nazwa elementu	D[mm]	S[mm]	G[mm]	Ilość
1	Blat Lewy	800	600	32	1
2	Blat Prawy	800	600	32	1
3	Wkładka	800	400	32	1

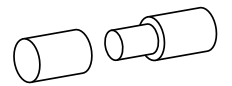

A - 8 St.



B - 4 St.

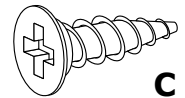

C - 8 St.
3,5x16 mm

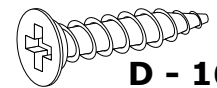

D - 16 St.
3x25 mm

I

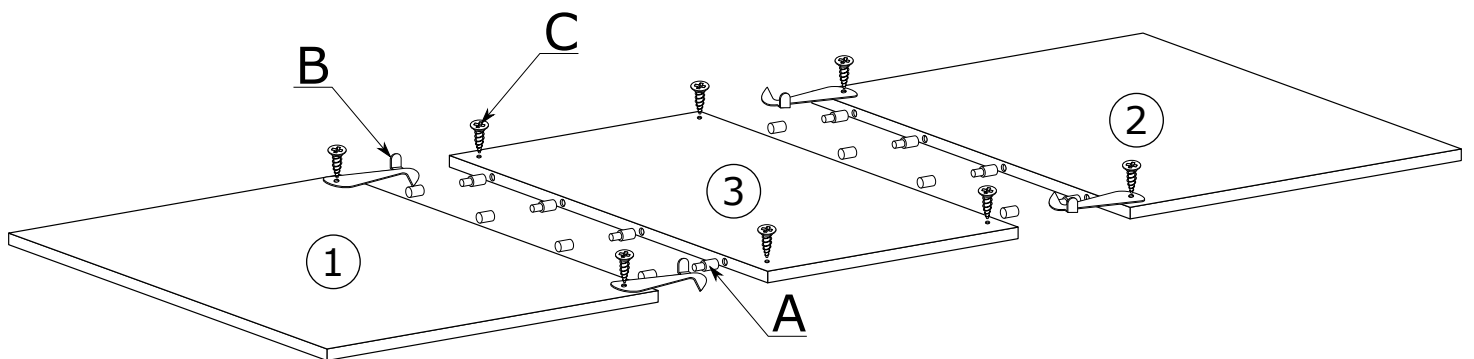

II

