

INDIANAPOLIS 21



Narzędzia potrzebne do montażu



UWAGA !!!

MONTOWANIE USZKODZONYCH
ELEMENTÓW POWODUJE UTRATĘ
GWARANCJI

Nr	D[mm]	S[mm]	G[mm]	Ilość
1	1338	300	16	2
2	368	295	16	1
3	368	295	16	1
4	400	300	16	1
5	400	300	16	1
6	395	80	16	2
7	360	405	4	2
8	434	270	4	2
9	1360	390	2,5	1

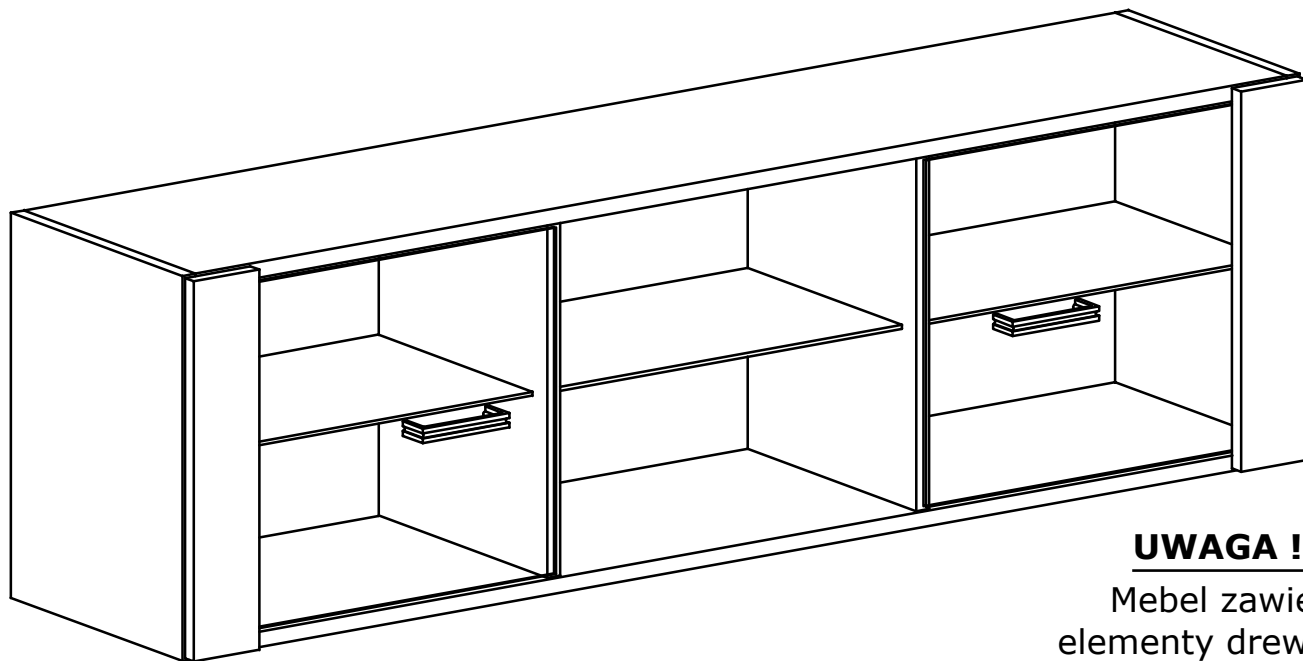

UWAGA !!!

Mebel zawiera
elementy drewniane

W przypadku reklamacji proszę podać numer pakowacza znajdujący się na kartonie.

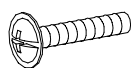

N - 4 St.
4x14 mm

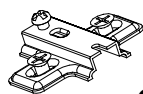

C - 4 St.

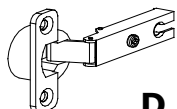

D - 4 St.



R - 10 St.

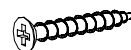

H - 4 St.
3x30 mm

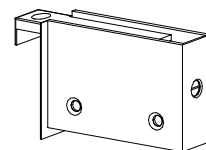

J - 2 St.



F - 12 St.



A - 8 St.



U - 2 St.

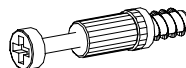

K - 8 St.



E - 40 St.



B - 16 St.



G - 16 St.
3,5x16 mm

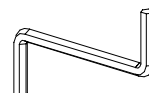

Z - 1 St.



L - 8 St.

I

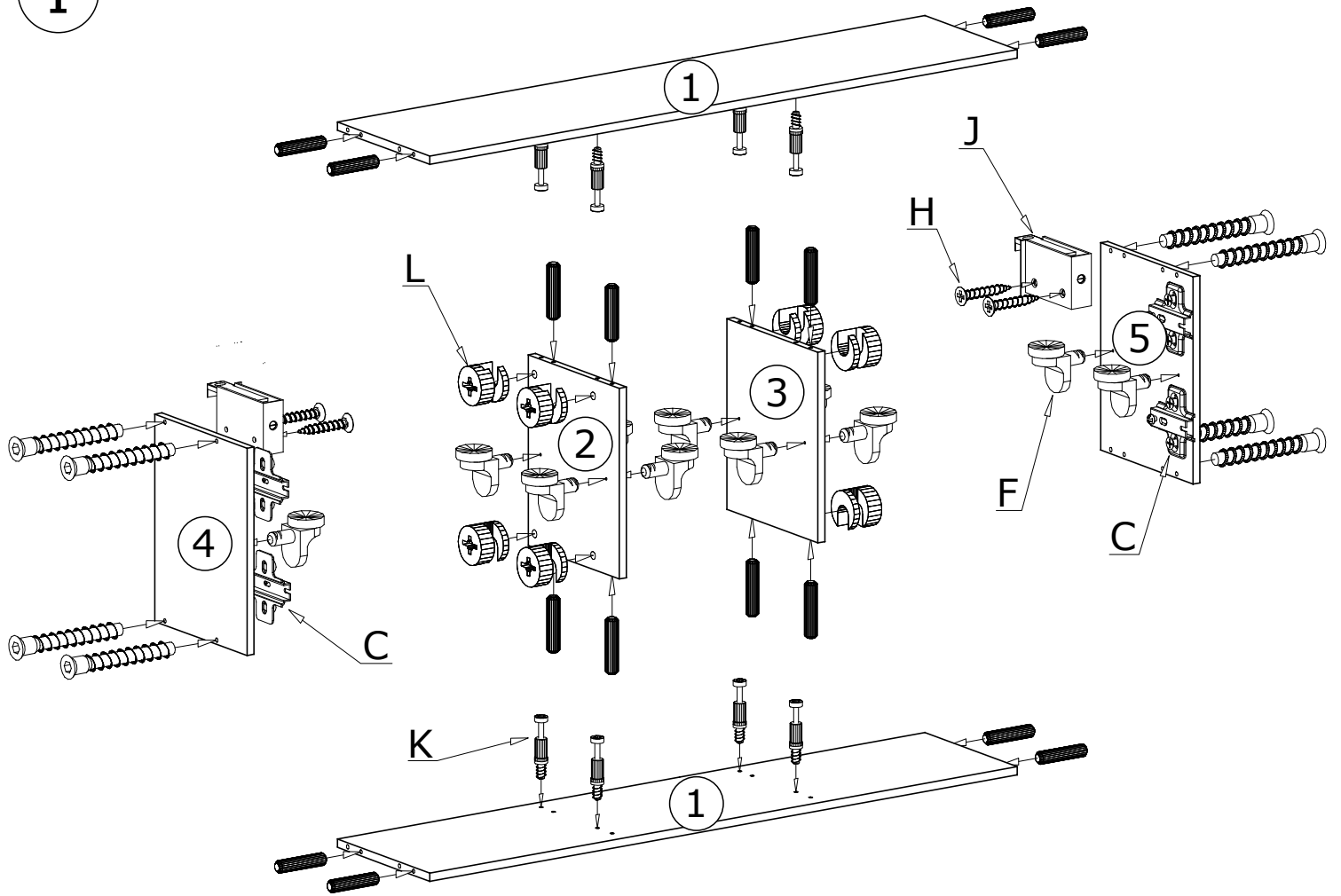

II

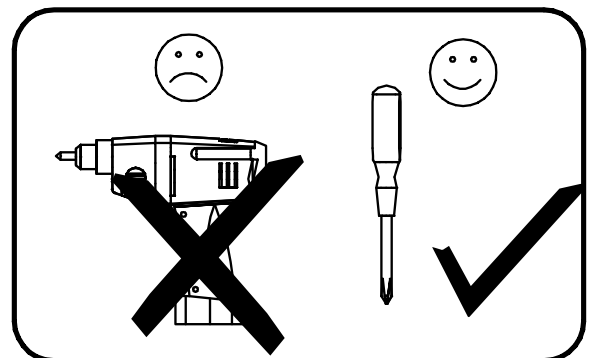
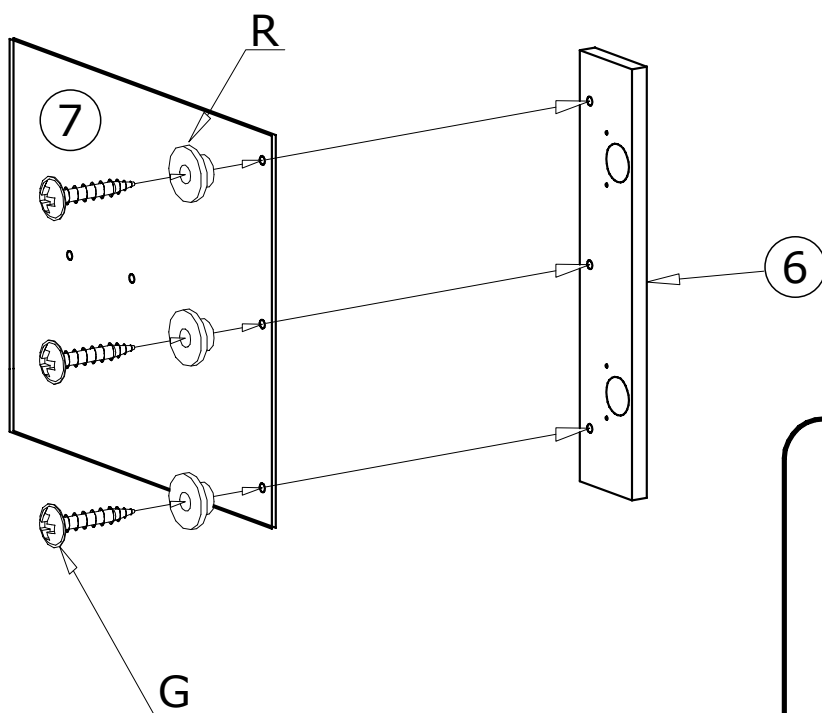

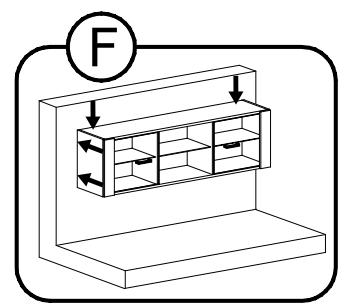
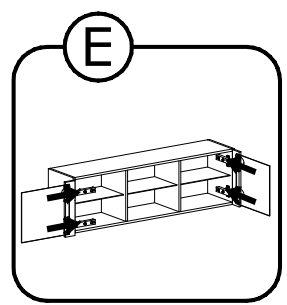
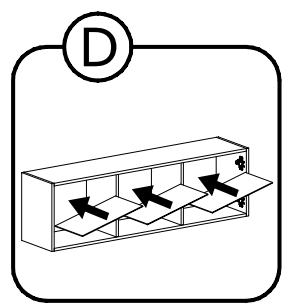
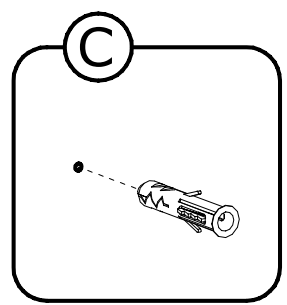
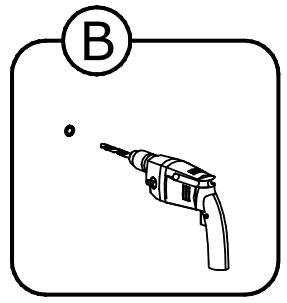
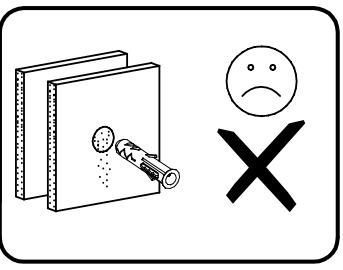
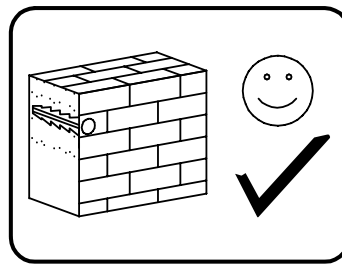
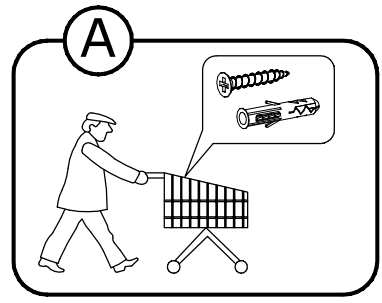
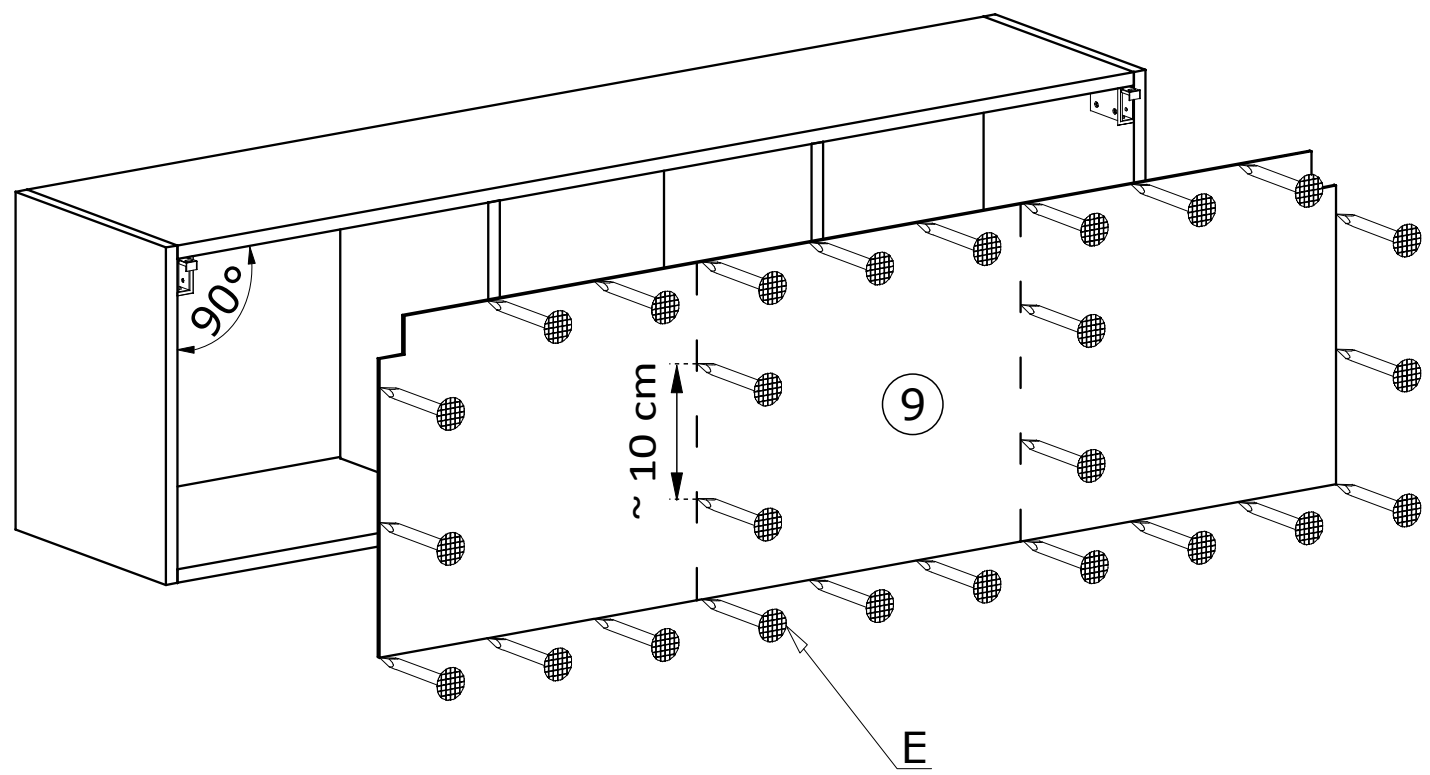

Meble zawierają elementy drewniane, których barwa i układ słoju są uzależnione od wielu czynników, dlatego mogą występować różnice w fakturze i barwie co nie stanowi wady produktu i nie wpływa na jego jakość, trwałość i funkcjonalność.

Listwy drewniane mogą ujawniać niewielkie zmiany w kształcie i wymiarach wywołane specyficznymi warunkami eksploatacji takimi jak: wilgotność, różnice temperatur, etc.

IV

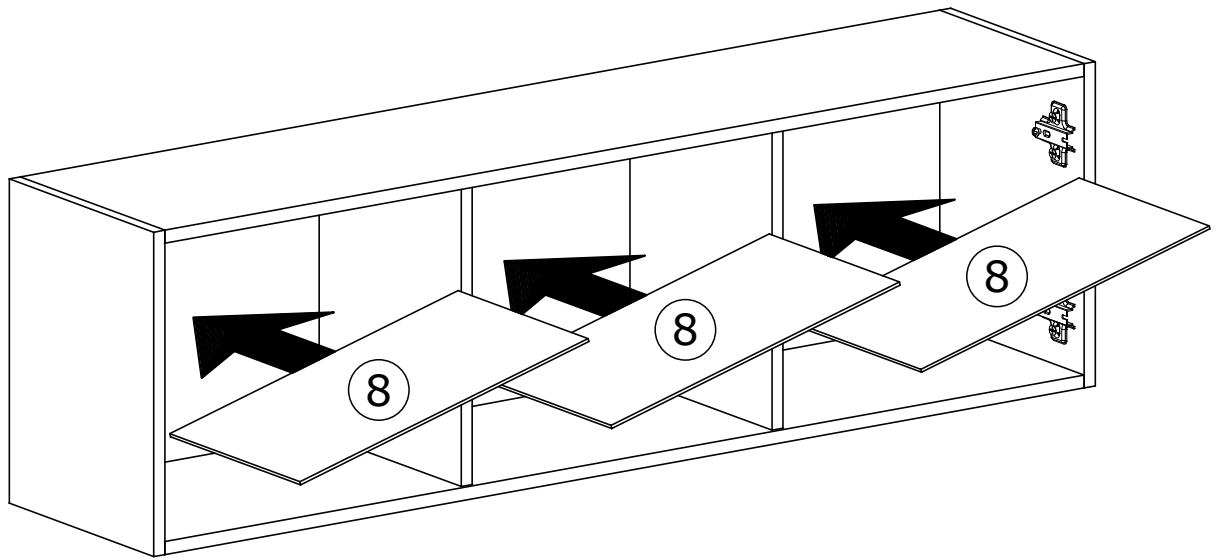

V

