

INDIANAPOLIS 23



Narzędzia potrzebne do montażu



UWAGA !!!

MONTOWANIE USZKODZONYCH
ELEMENTÓW POWODUJE UTRATĘ
GWARANCJI

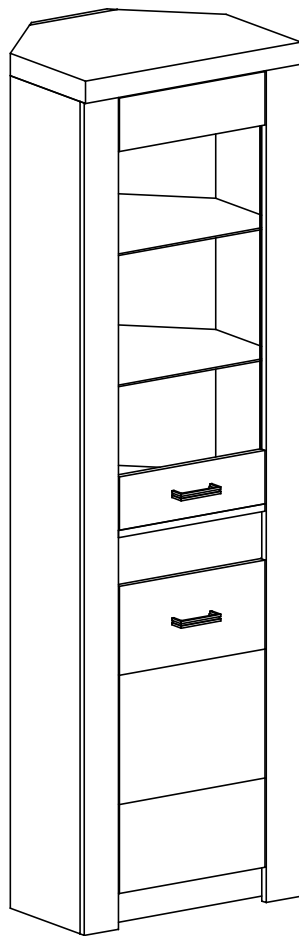

Nr	D[mm]	S[mm]	G[mm]	Ilość
1	527	453	16	1
2	1870	280	16	1
3	1870	280	16	1
4	527	435	16	1
5	527	80	16	1
6	527	123	16	1
7	1870	80	16	1
8	1870	80	16	1
9	1870	220	16	1
10	563	470	48	1
11	1800	255	2,5	2
12	527	425	16	1
13	781	395	4	1
14	395	120	16	1
15	395	120	16	1
16	526	423	4	2
17	665	395	16	1

UWAGA !!!

Mebel zawiera
elementy drewniane

W przypadku reklamacji proszę podać numer pakowacza znajdujący się na kartonie.



F - 2 St.

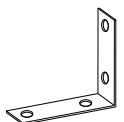

Y - 2 St.

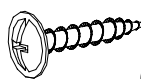

Q - 4 St.
3,5x16 mm

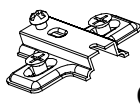

C - 4 St.

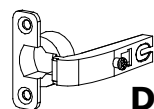

D - 4 St.

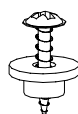

R - 6 St.

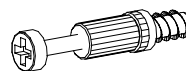

K - 12 St.

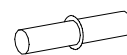

P - 6 St.

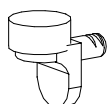

S - 14 St.



T - 8 St.



U - 2 St.

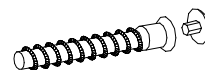

A - 14 St.

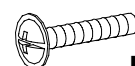

N - 4 St.
4x25 mm



E - 50 St.



B - 24 St.



G - 14 St.
3,5x16 mm

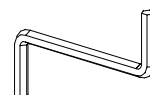

Z - 1 St.



L - 12 St.

I

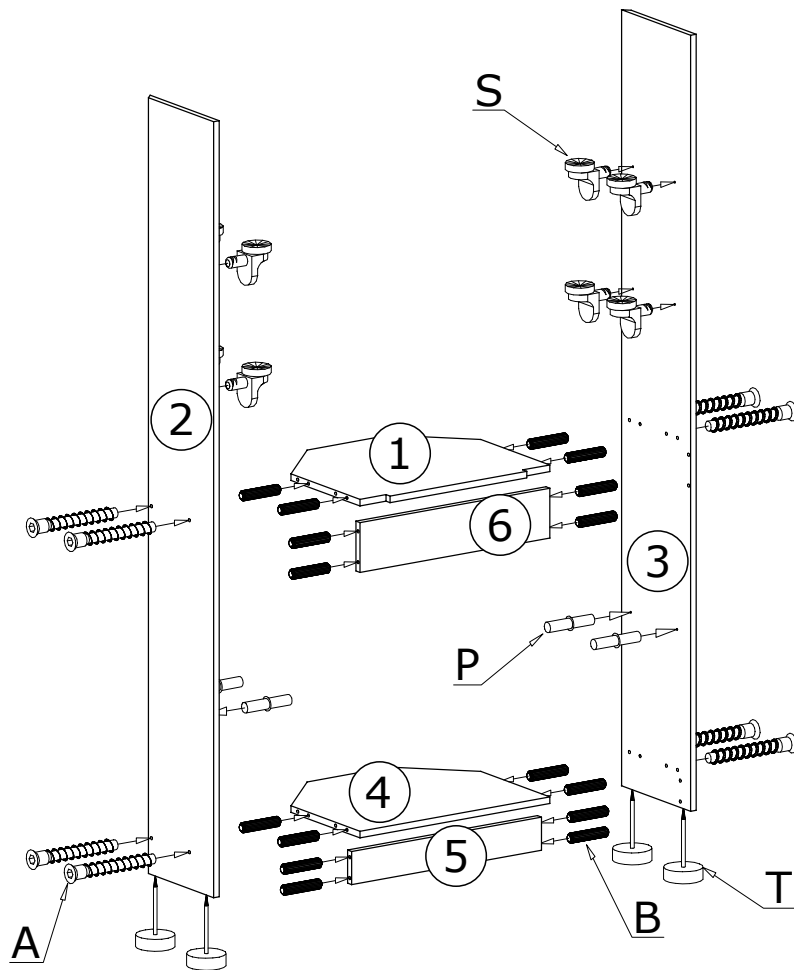

II

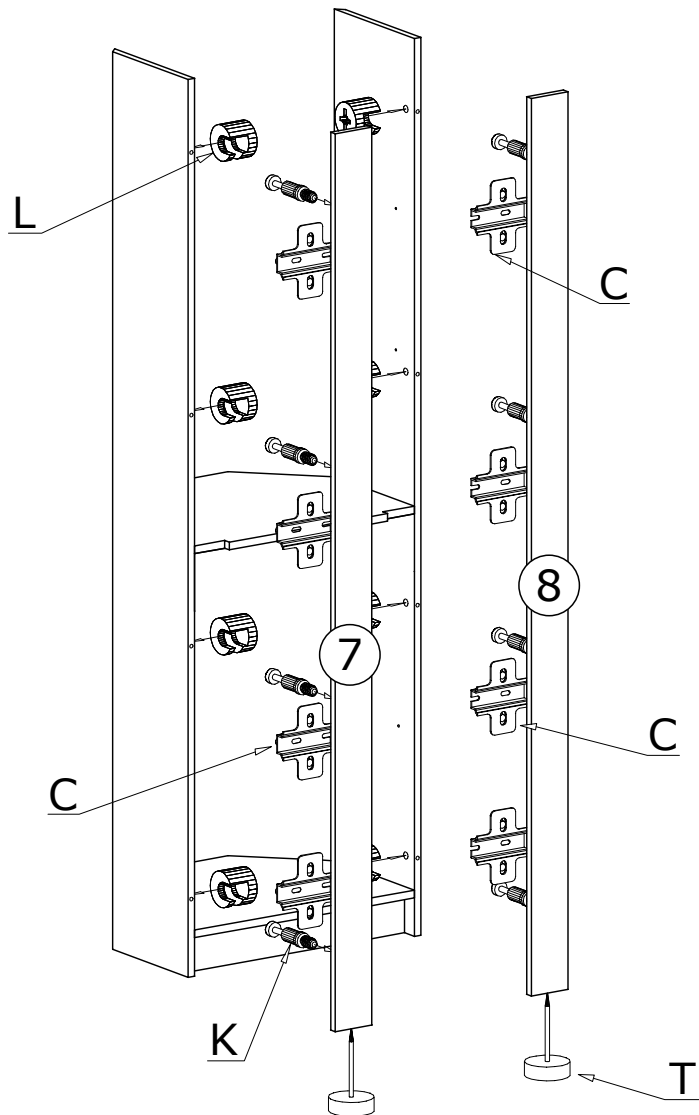

Prowadnik zawiasu "C" zamontować na lewej lub prawej listwie w zależności, na którą stronę mają otwierać się drzwi.

III

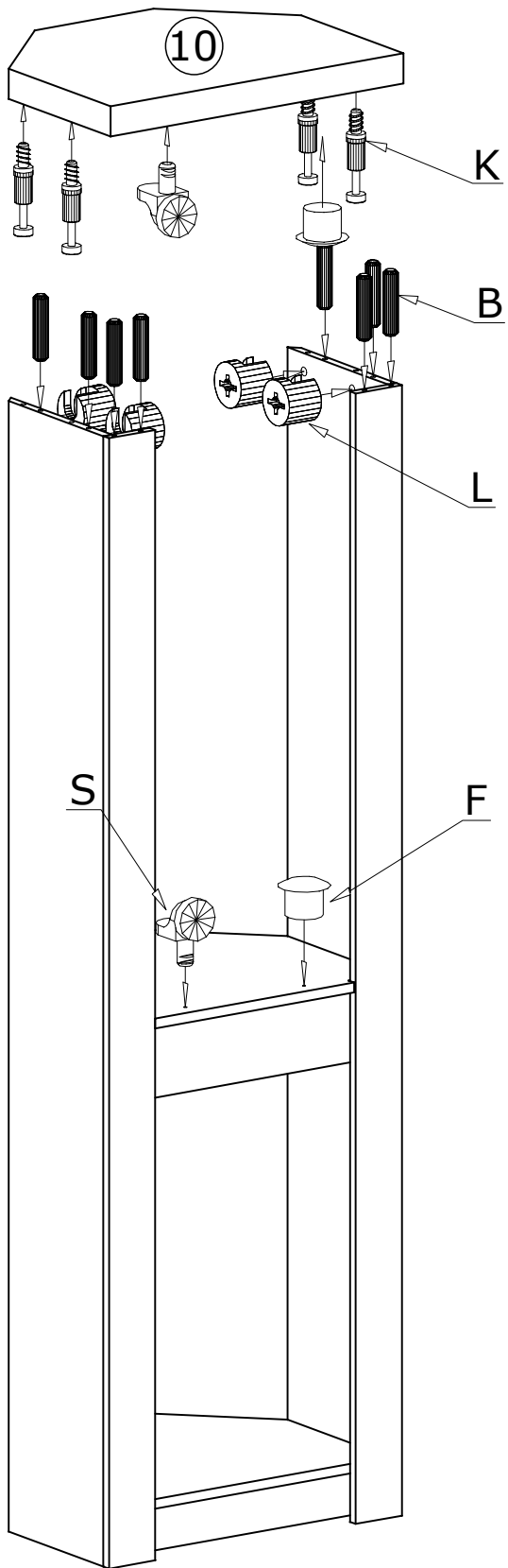

IV

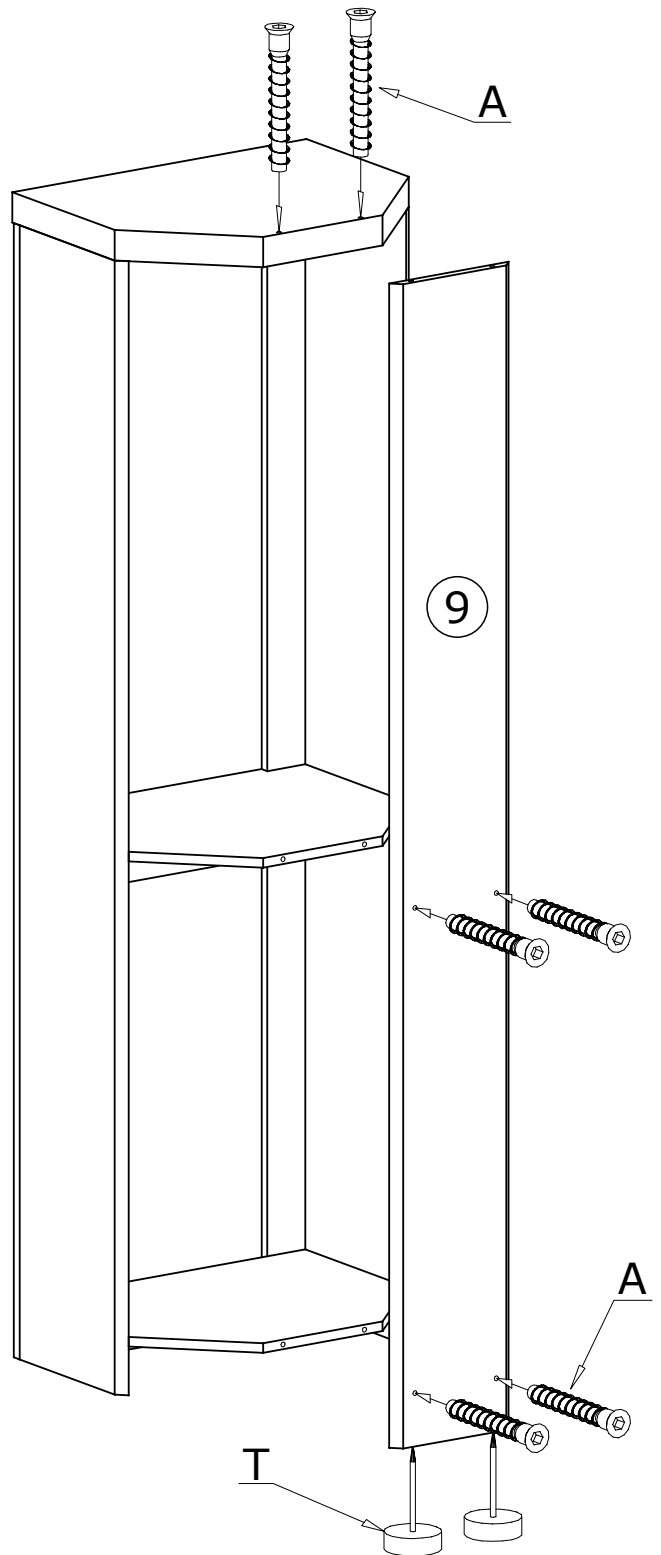

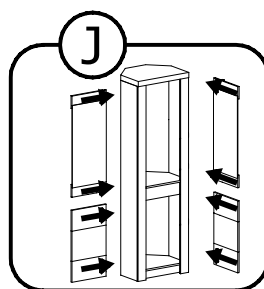
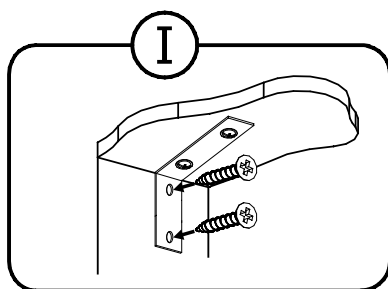
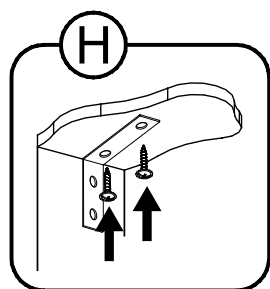
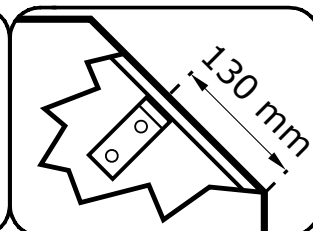
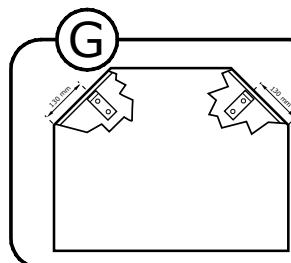
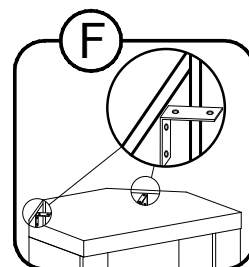
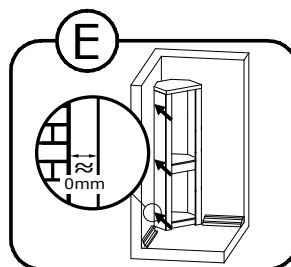
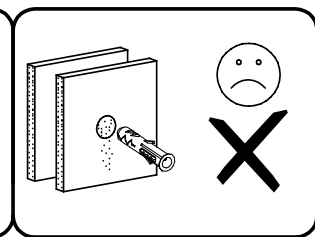
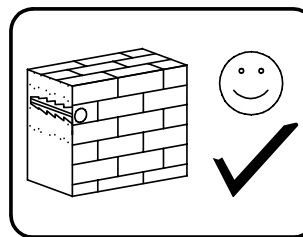
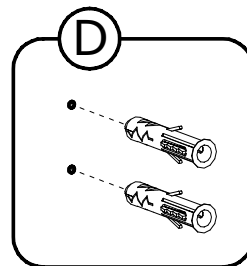
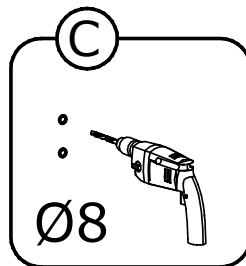
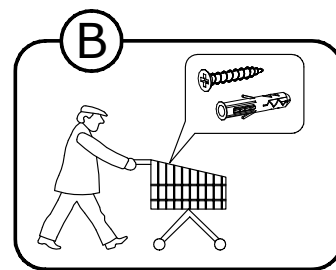
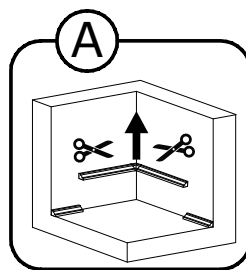
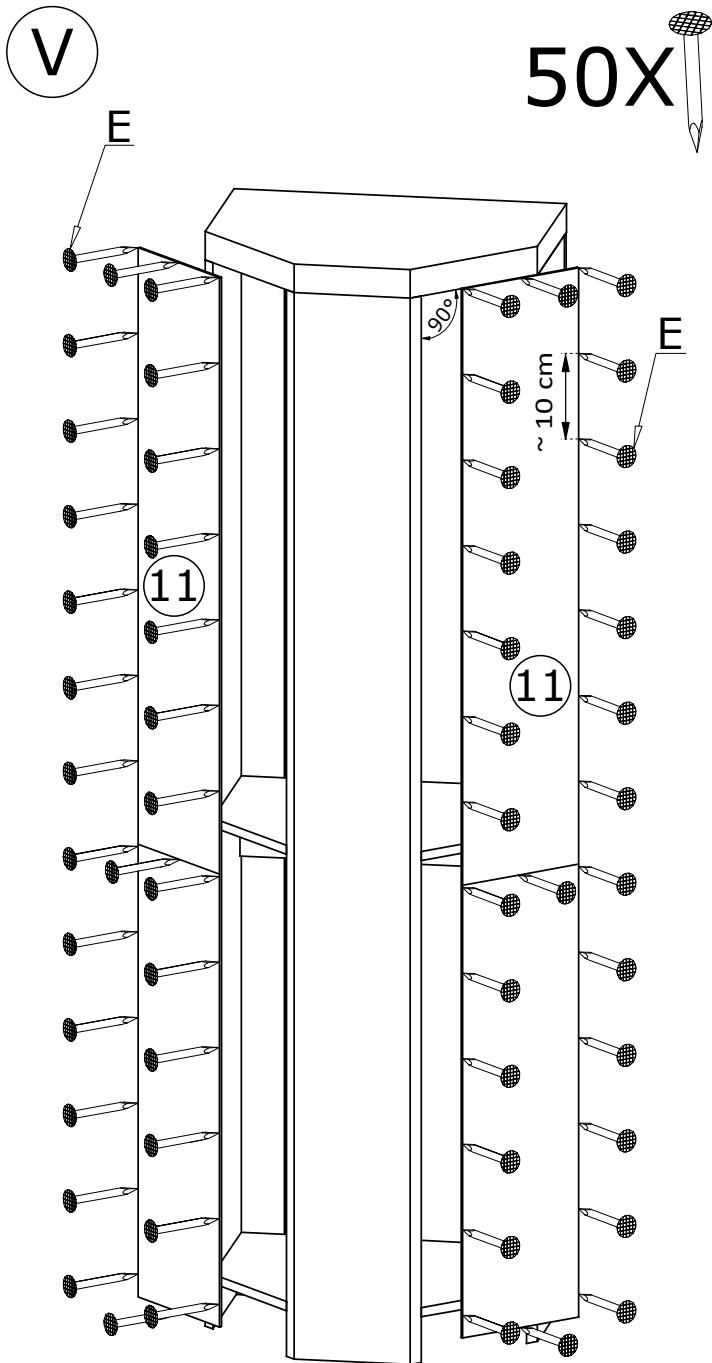

Meble zawierają elementy drewniane, których barwa i układ słoju są uzależnione od wielu czynników, dlatego mogą występować różnice w fakturze i barwie co nie stanowi wady produktu i nie wpływa na jego jakość, trwałość i funkcjonalność.

Listwy drewniane mogą ujawniać niewielkie zmiany w kształcie i wymiarach wywołane specyficznymi warunkami eksploatacji takimi jak: wilgotność, różnice temperatur, etc.

VI

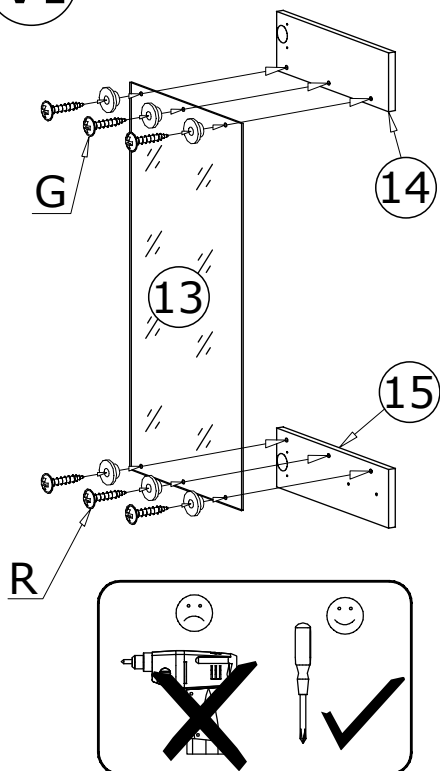

Drzwi zamontować na lewą lub prawą stronę.

VII

