

TADEUSZ 7

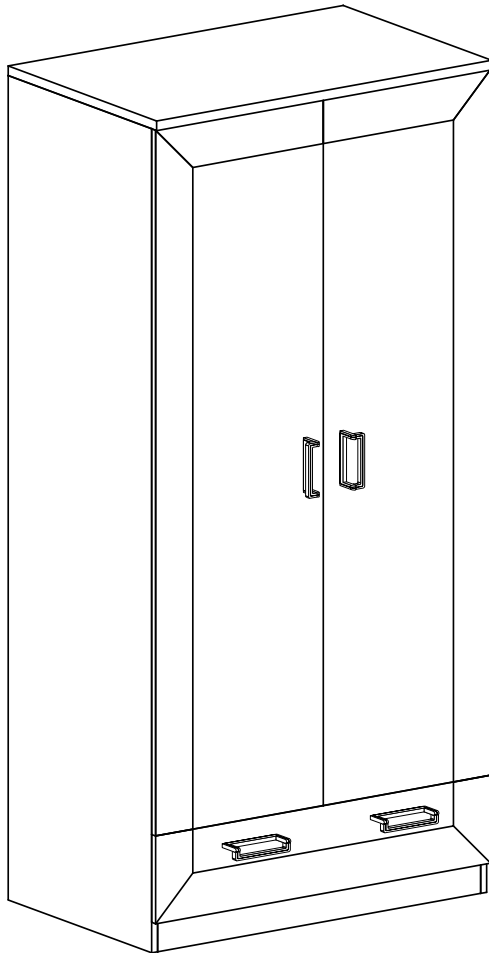

Narzędzia potrzebne do montażu



UWAGA !!!

MONTOWANIE USZKODZONYCH
ELEMENTÓW POWODUJE UTRATĘ
GWARANCJI

Nr	D[mm]	S[mm]	G[mm]	Ilość
1	900	575	32	1
2	851	540	16	1
3	851	540	16	1
4	853	80	16	1
5	1800	876	2,5	1
6	1870	540	16	1
7	1870	540	16	1
8	1586	438	16	1
9	1586	438	16	1
10	880	190	16	1
11	500	150	16	1
12	500	150	16	1
13	796	150	16	1
14	825	505	2,5	1

W przypadku reklamacji proszę podać numer pakowacza znajdujący się na kartonie.

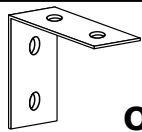

O - 1 St.

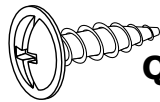

Q - 2 St.
3,5x16 mm



X1 - 8 St.



X2 - 9 St.

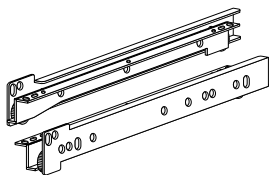

T - 1 Kpl.

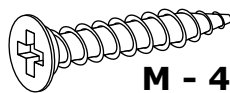

M - 4 St.
4x25 mm



R - 1 St.

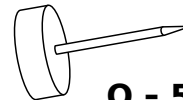

Q - 5 St.

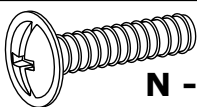

N - 8 St.
4x22 mm

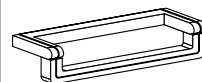

U - 4 St.

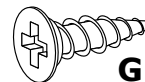

G - 16 St.
3,5x16 mm

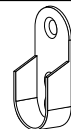

Y - 2 St.



F - 4 St.



E - 60 St.

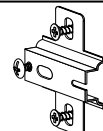

C - 6 St.

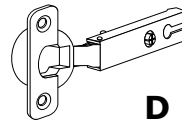

D - 6 St.



L - 8 St.

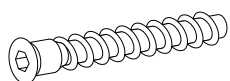

R - 9 St.

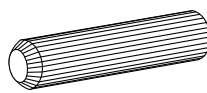

B - 20 St.

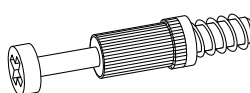

K - 8 St.

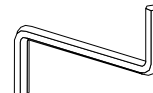

Z - 1 St.

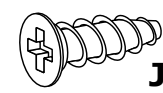

J - 4 St.
5x13 mm

I

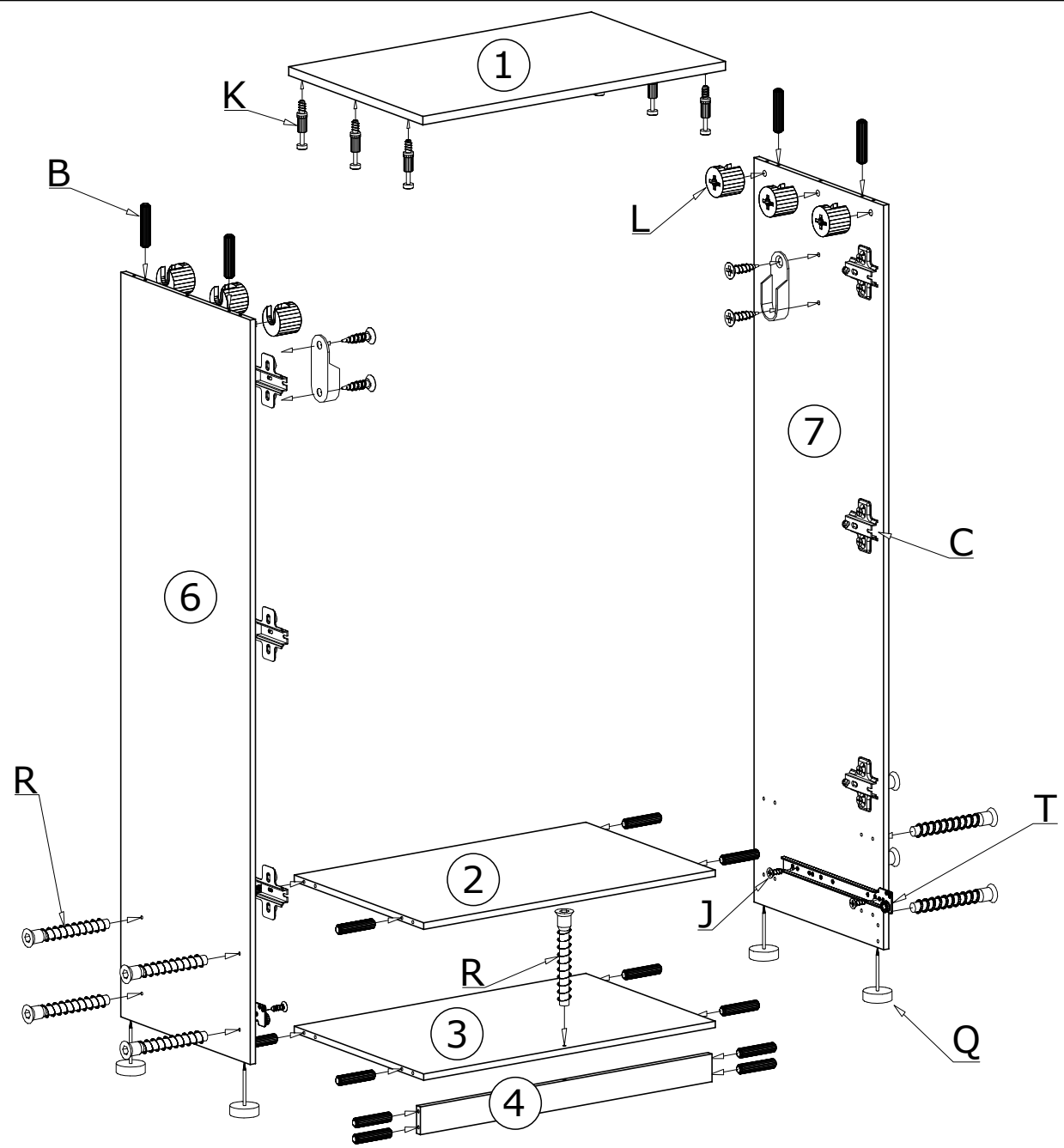

II

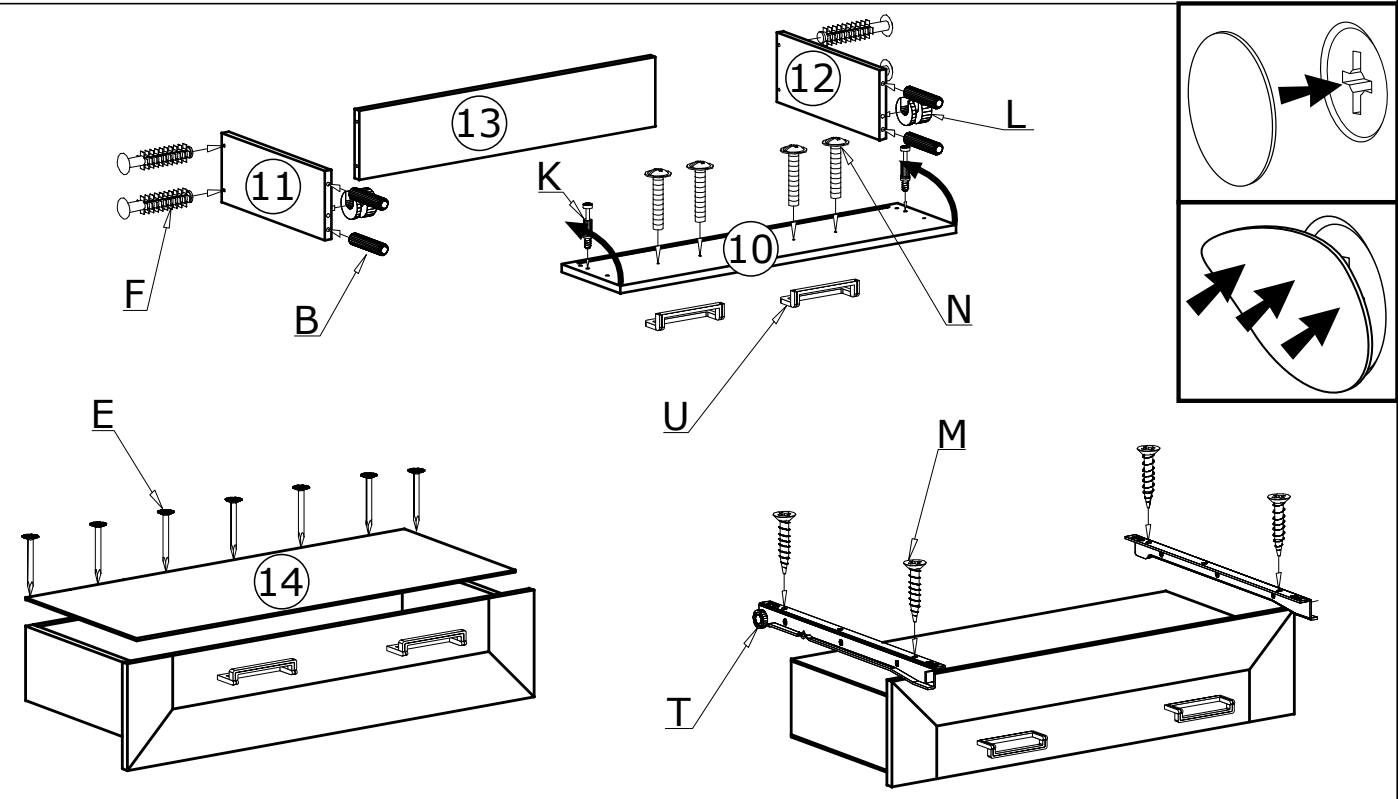

III

60X 

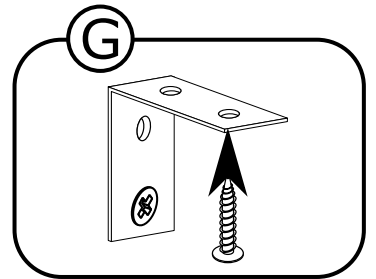
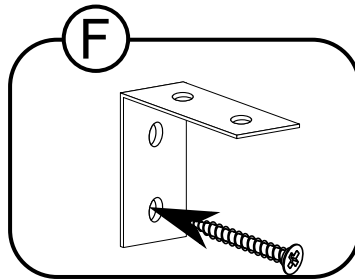
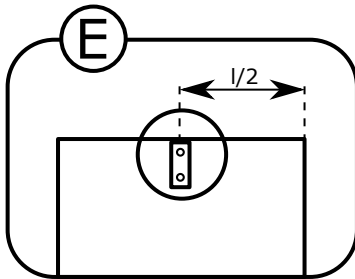
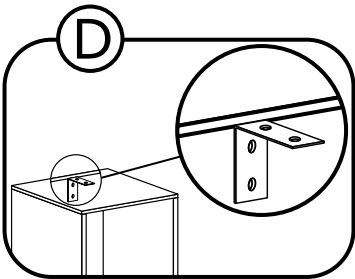
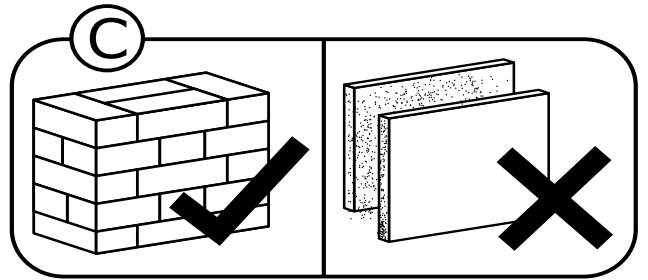
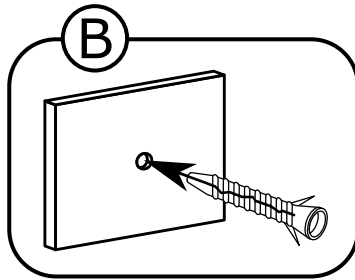
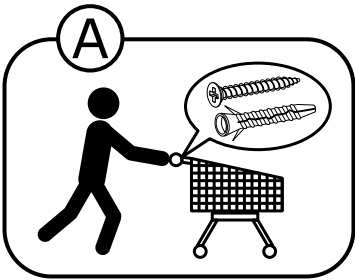
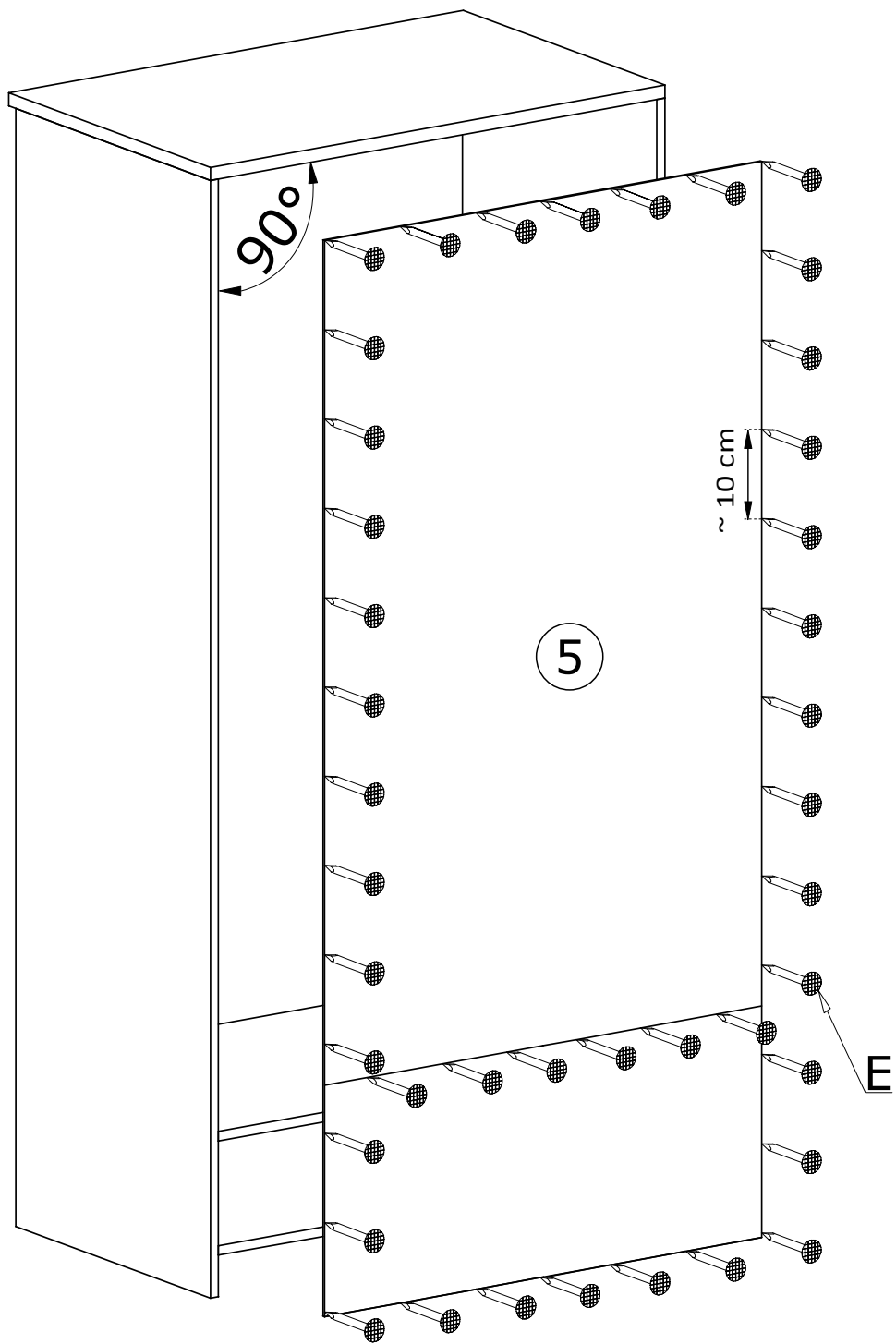

IV

