

PRZED ROZPOCZĘCIEM MONTAŻU ZAPOZNAĆ SIĘ Z INSTRUKCJĄ

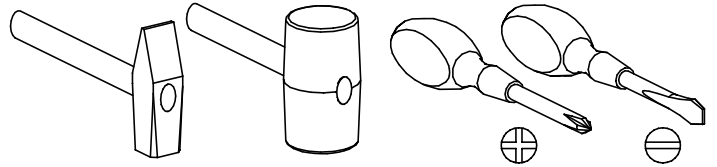

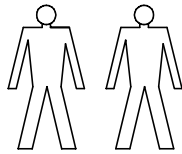



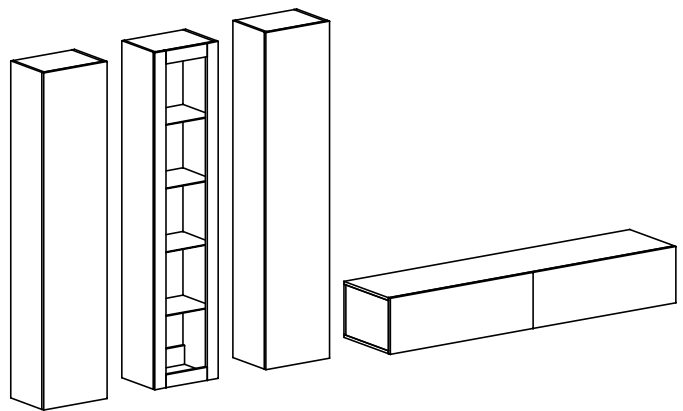
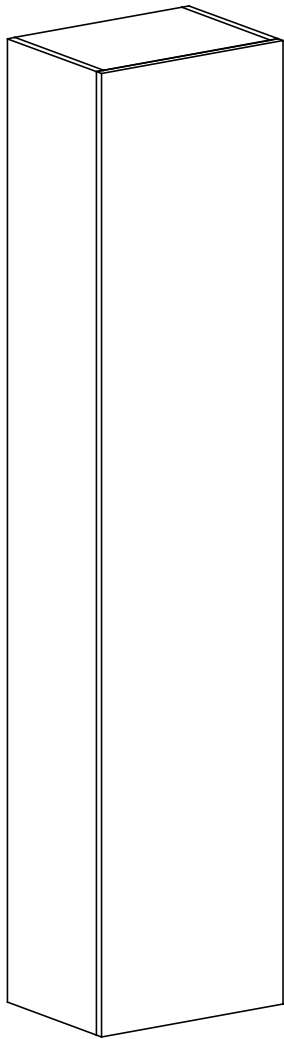

Narzędzia niezbędne do montażu (nie dostarczane przez producenta)

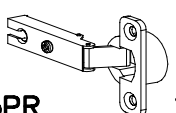
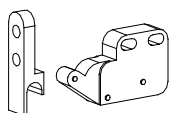

# VIGO

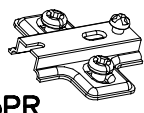
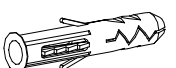
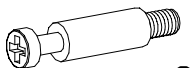
## Szafka wisząca

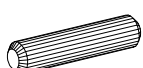
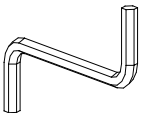

		<b>G31</b>  3 x 12      x2	<b>G30</b>  3 x 20      x2	<b>W4</b>  x57
<b>C3</b>  Z35PR      x4	<b>L9</b>  x1	<b>A2</b>  ø7 x 70      x4	<b>D3</b>  PZ35PR      x4	<b>U8</b>  x4
<b>K5</b>  x20	<b>K1</b>  ø15 x 12      x20	<b>B1</b>  x28	<b>W2</b>  x1	<b>G5</b>  4 x 13      x8

I

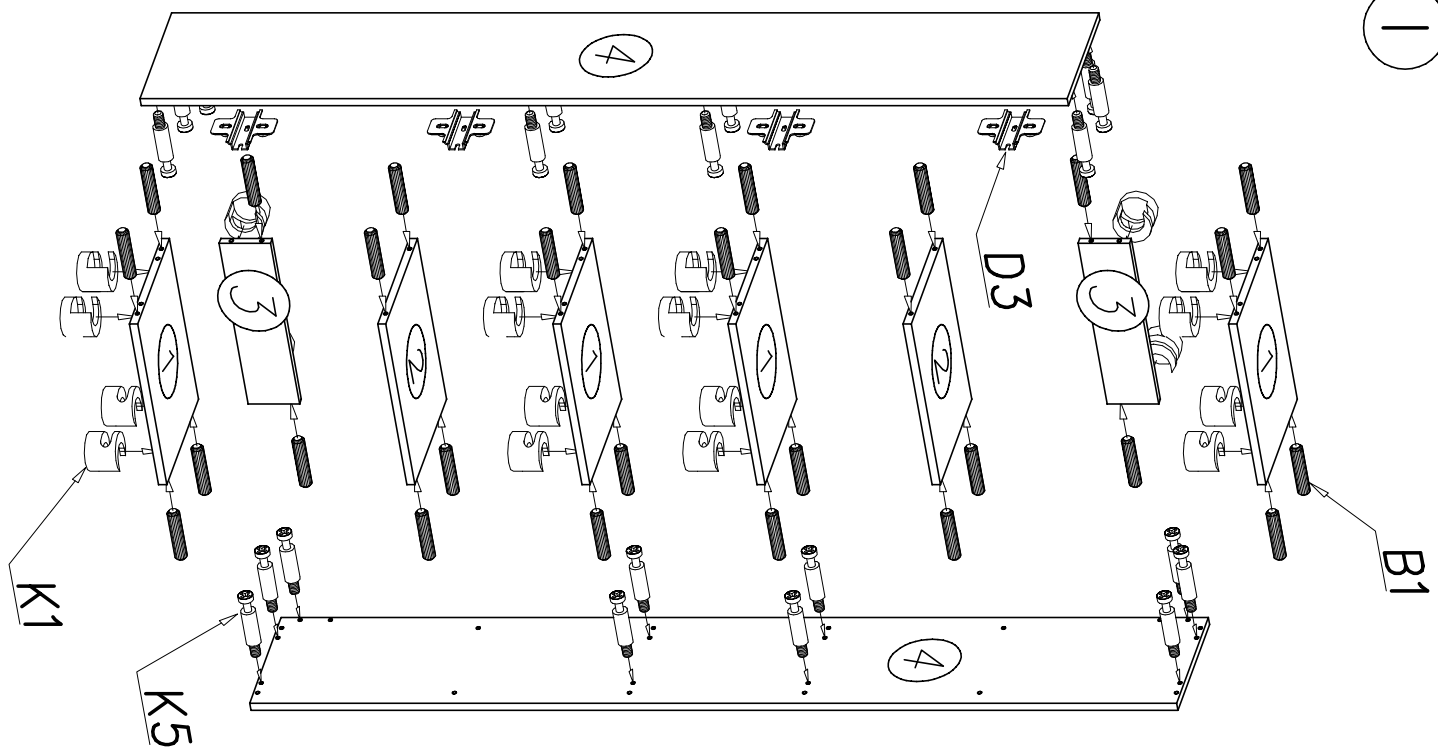

II

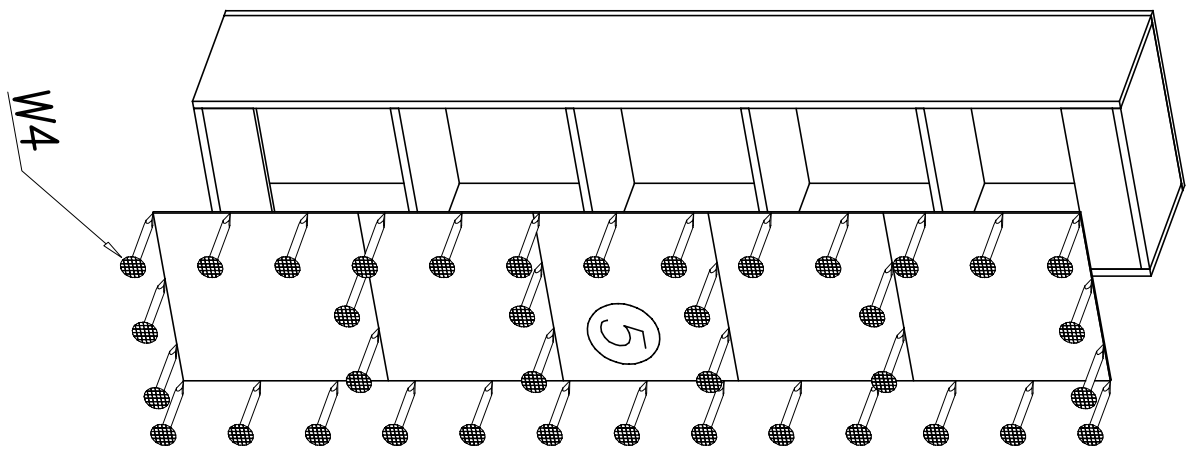

III

