

PRZED ROZPOCZĘCIEM MONTAŻU ZAPOZNAĆ SIĘ Z INSTRUKCJĄ

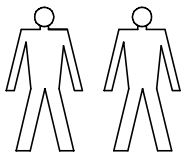

Narzędzia niezbędne do montażu (nie dostarczane przez producenta)

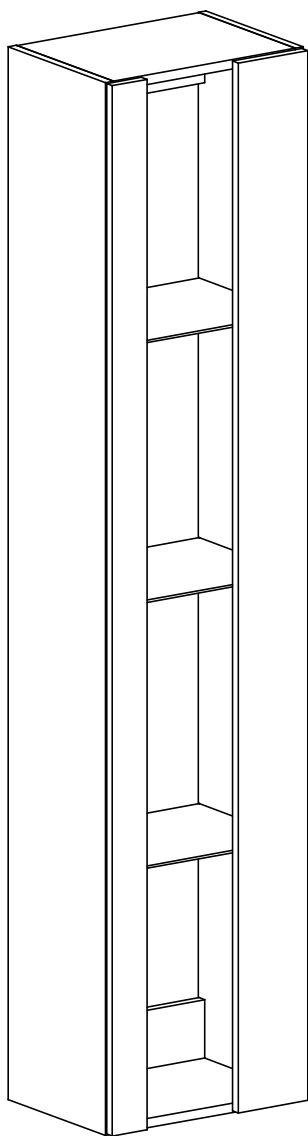
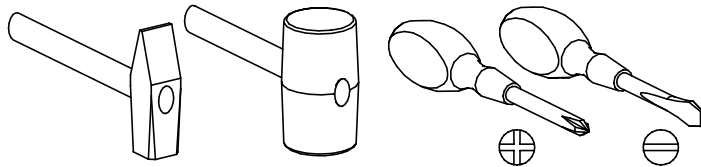

VIGO II

Witryna

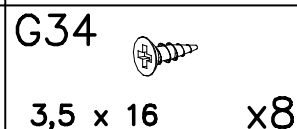
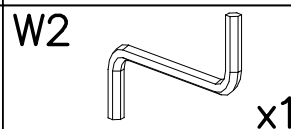
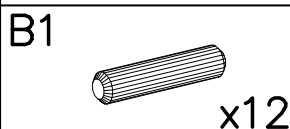
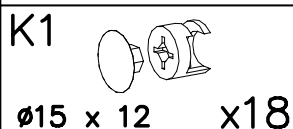
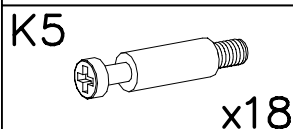
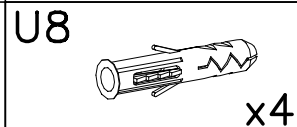
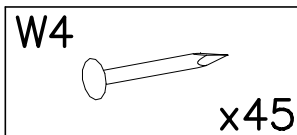
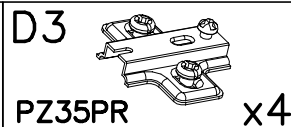
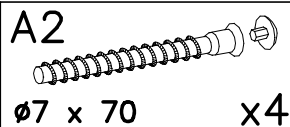
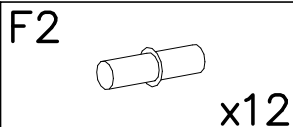
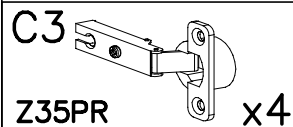

I

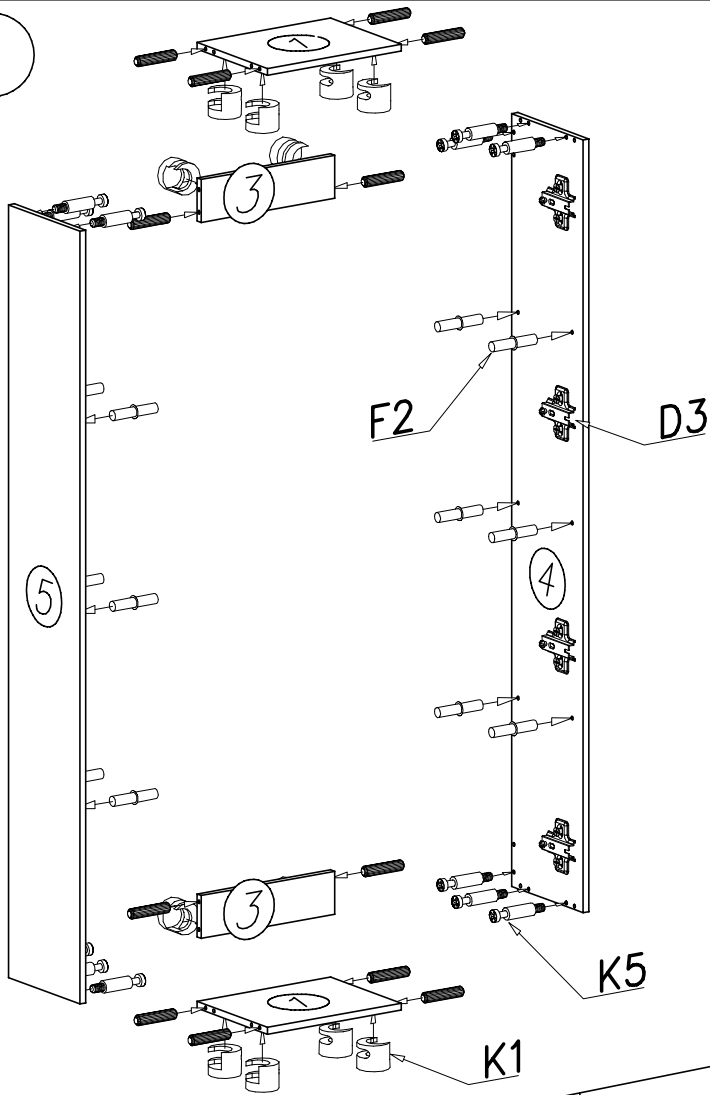

II

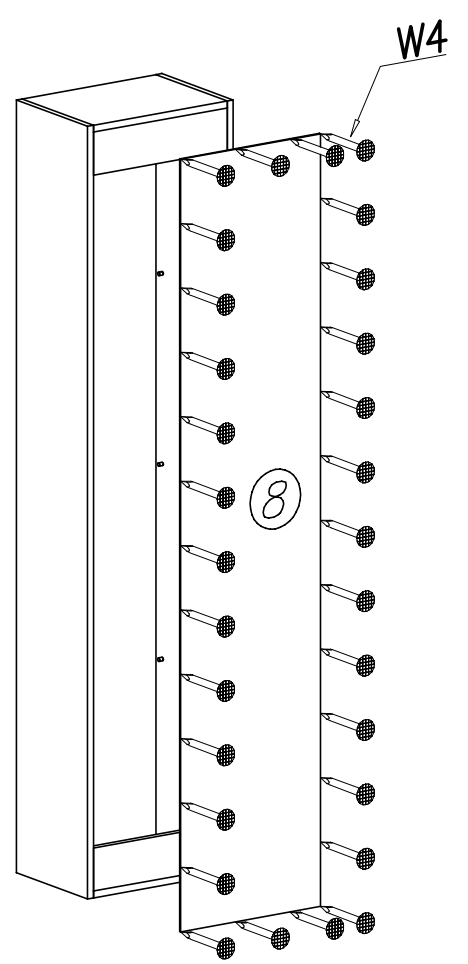

III

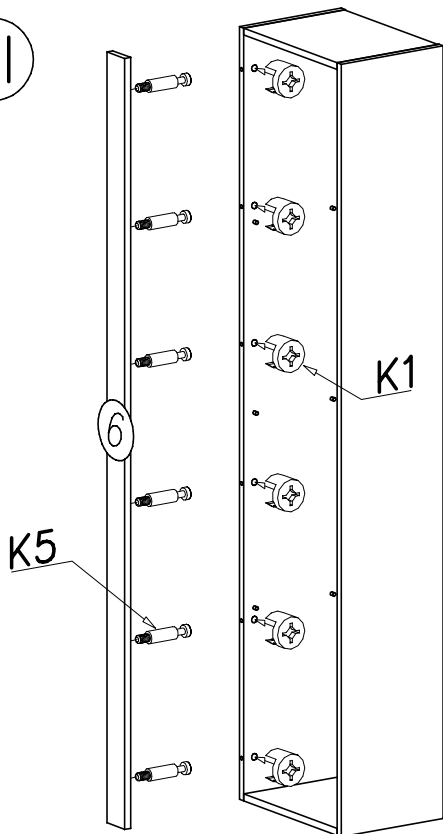

IV

