

**POZYCJONOWANIE LISTEW
SKIRTING POSITIONING
ROCKPOSITIONIERUNG**

LAMELO 2

100

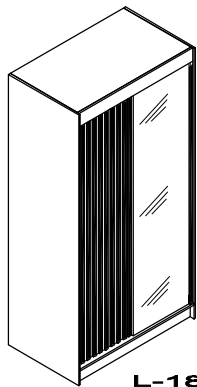

L-1872mm
11szt

120

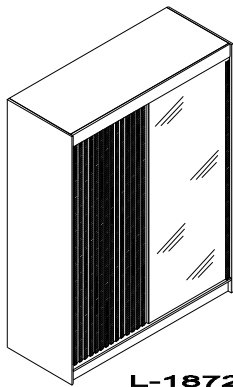

L-1872mm
13szt

150

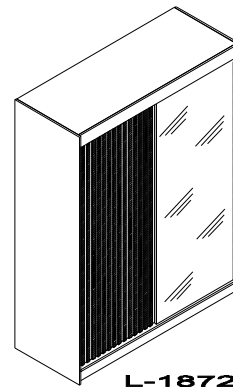

L-1872mm
16szt

180

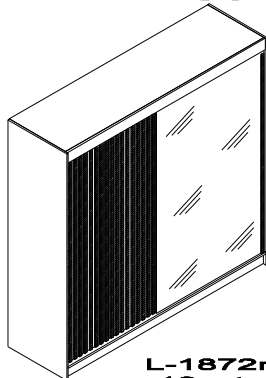

L-1872mm
19szt

200

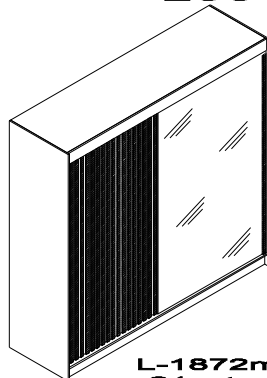

L-1872mm
21szt

250

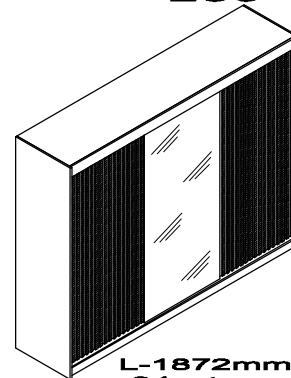

L-1872mm
34szt

Rysunek poglądowy dokładna ilość
strona 1
Demonstrative drawing exact
quantity page 1
Demonstrationszeichnung genaue
Stückzahl Seite 1

1



2

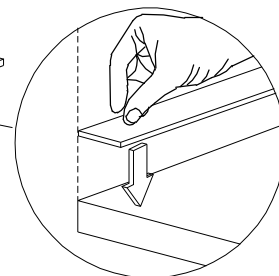
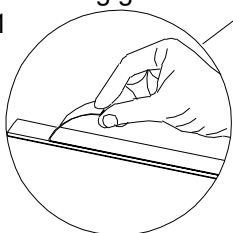
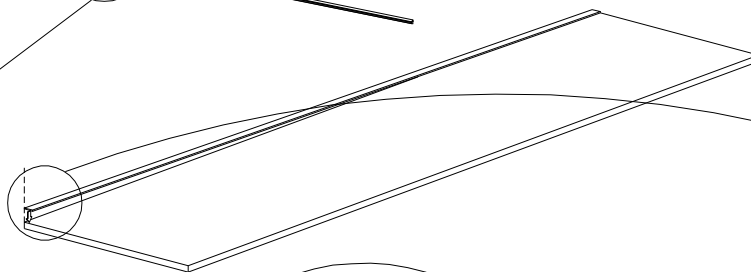

Przed naklejeniem wyczyścić
powierzchnię
Clean the surfaces before sticking
Reinigen Sie die Oberflächen vor
dem Aufkleben

3

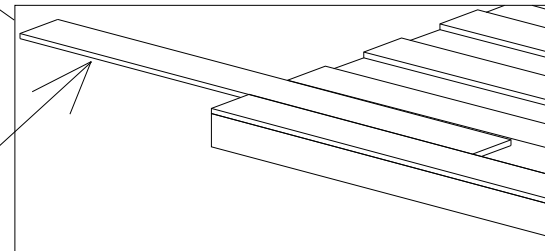
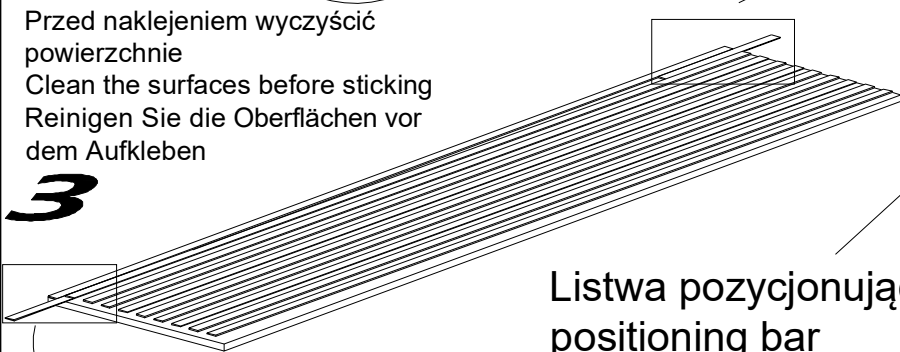

Listwa pozycjonująca
positioning bar
Positionierungsstange

4

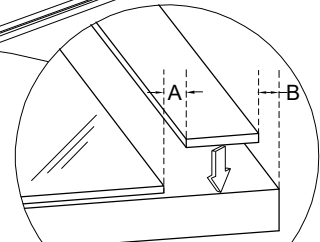
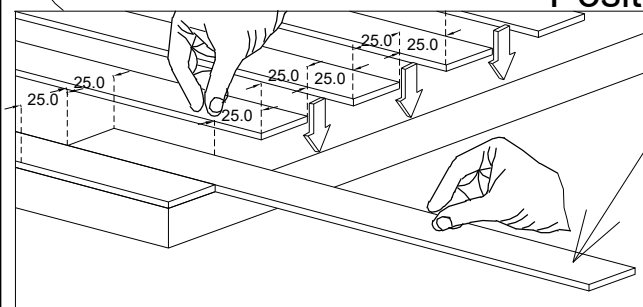
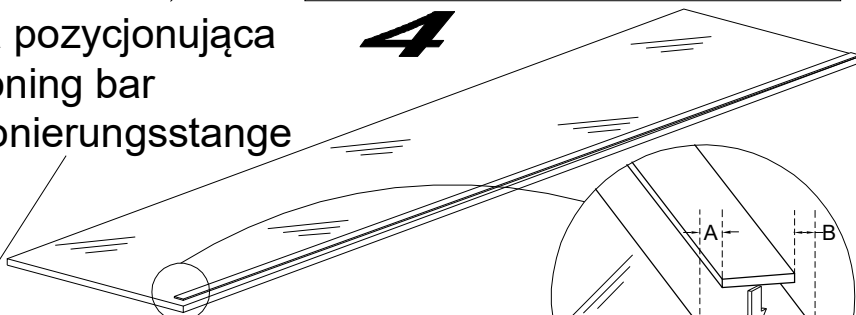

! A=B !