

COMO

V

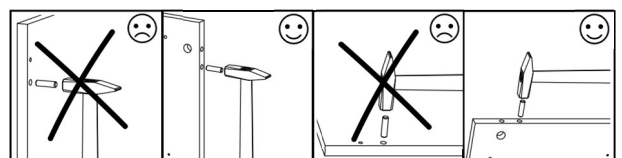

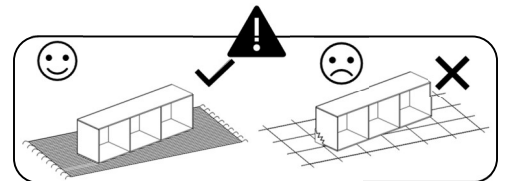
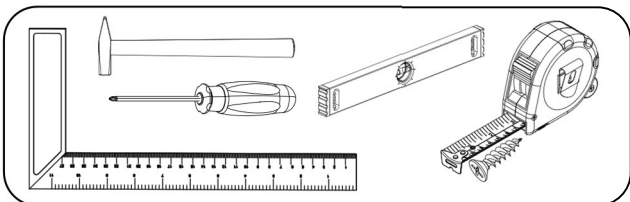
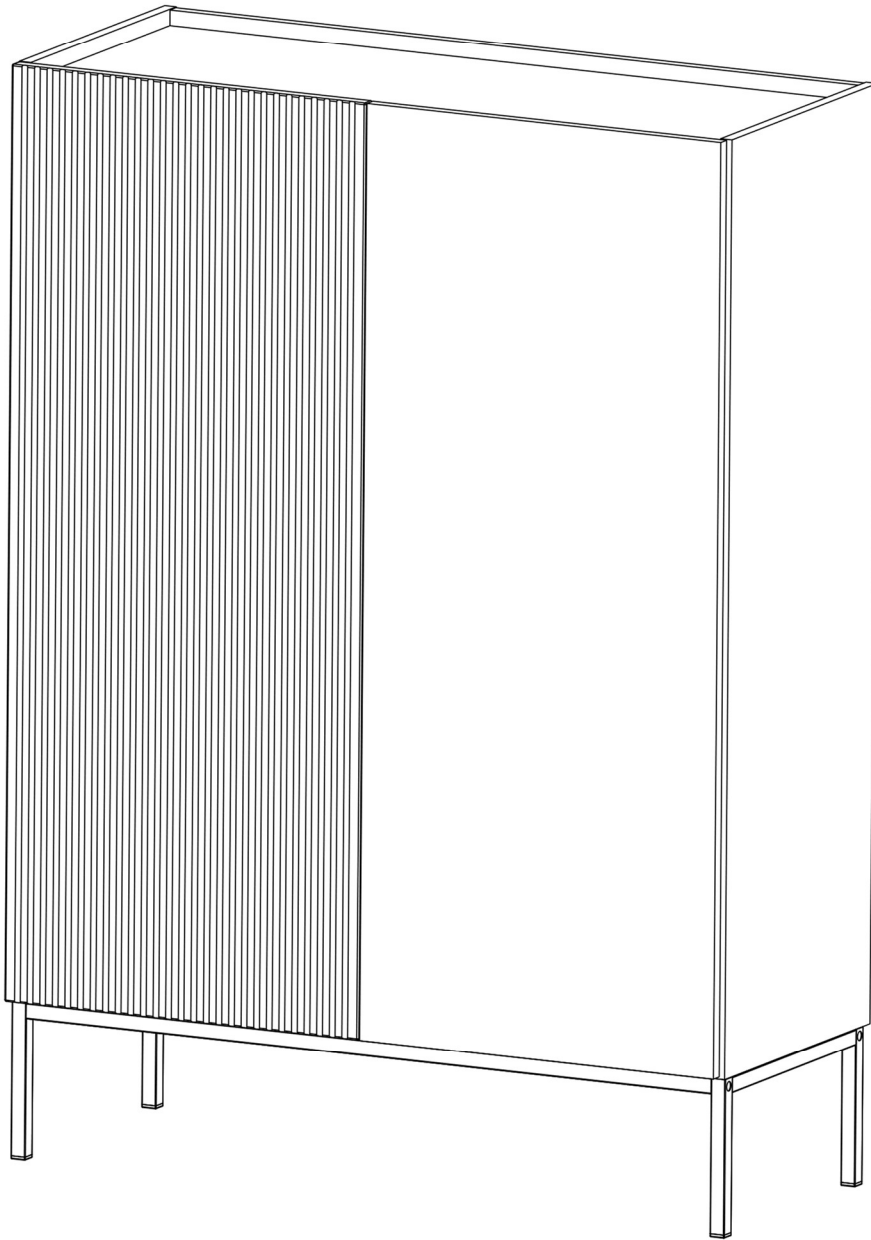
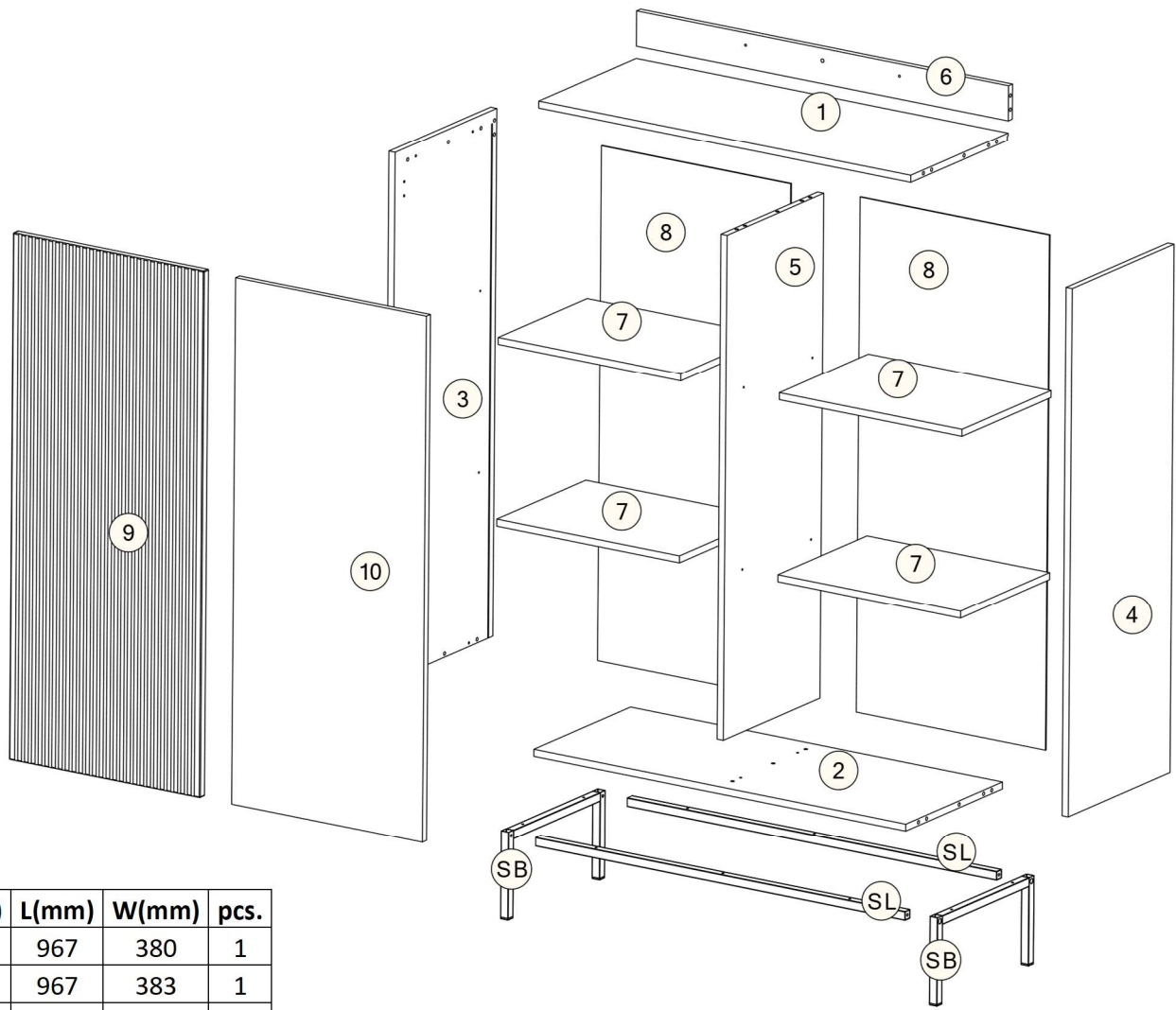

No	T(mm)	L(mm)	W(mm)	pcs.
1	16	967	380	1
2	16	967	383	1
3	16	1200	400	1
4	16	1200	400	1
5	16	1147	380	1
6	16	967	80	1
7	16	475	380	4
8	3	1170	492	2
9	18	1196	496	1
10	16	1196	496	1

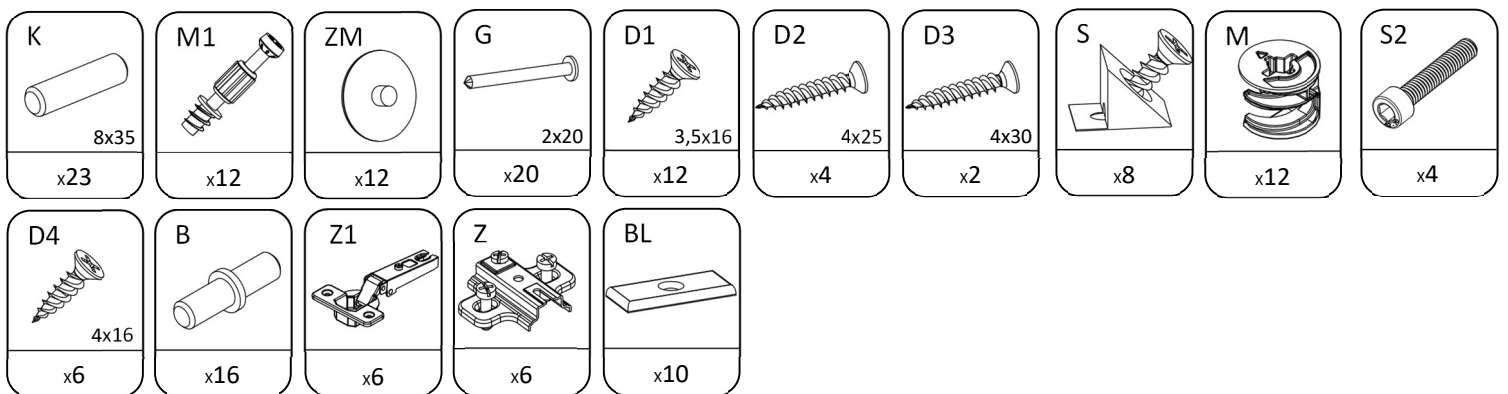
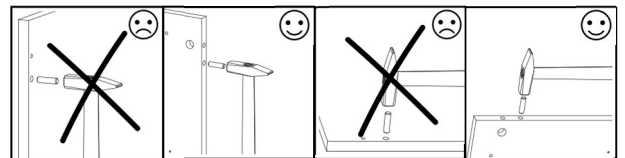
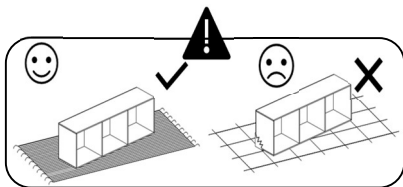

1

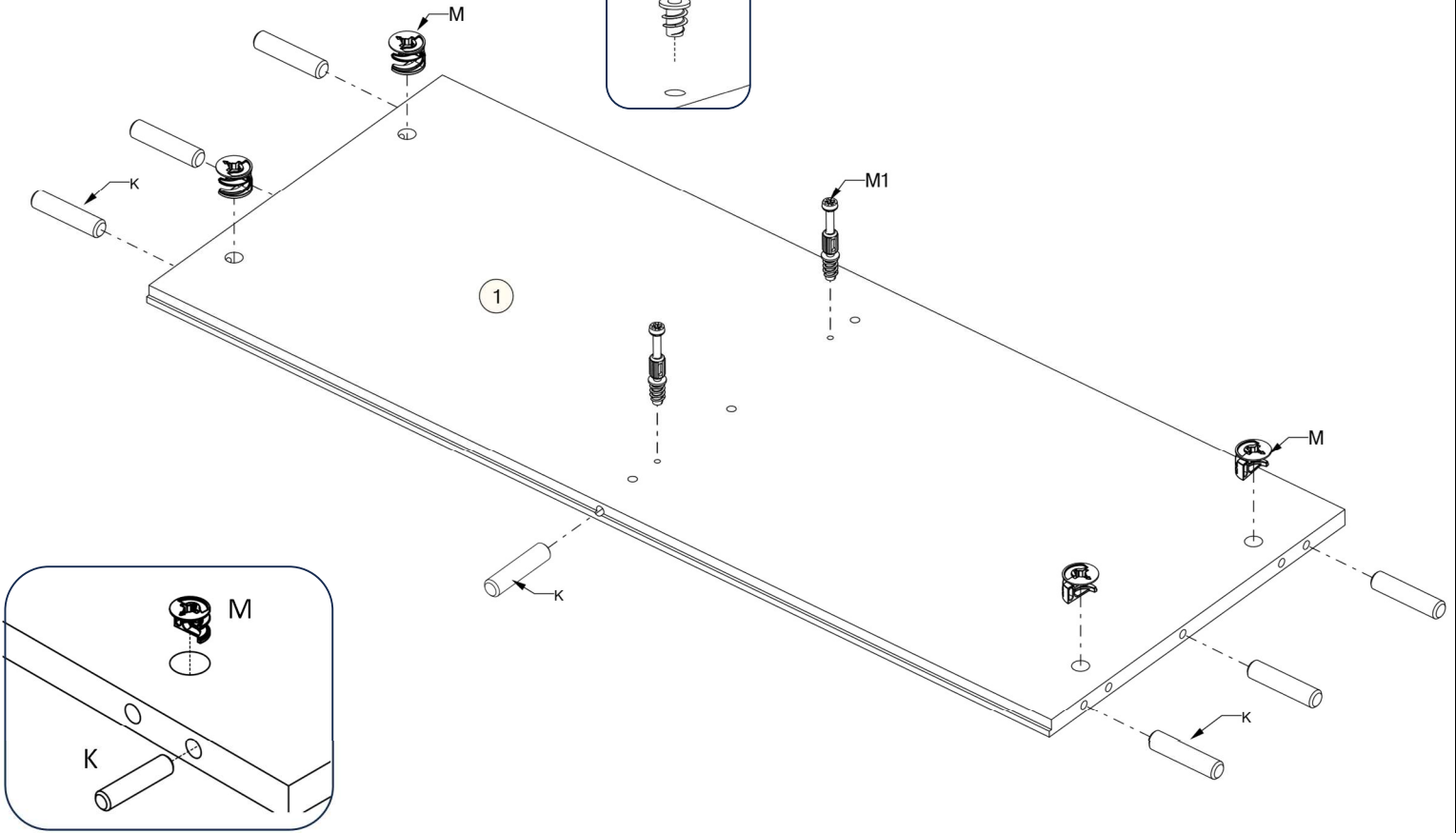
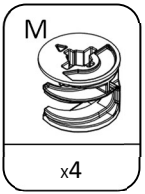
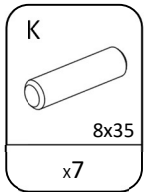
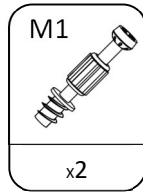
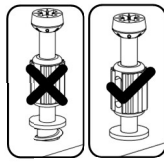
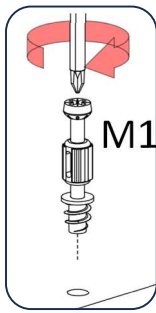

2

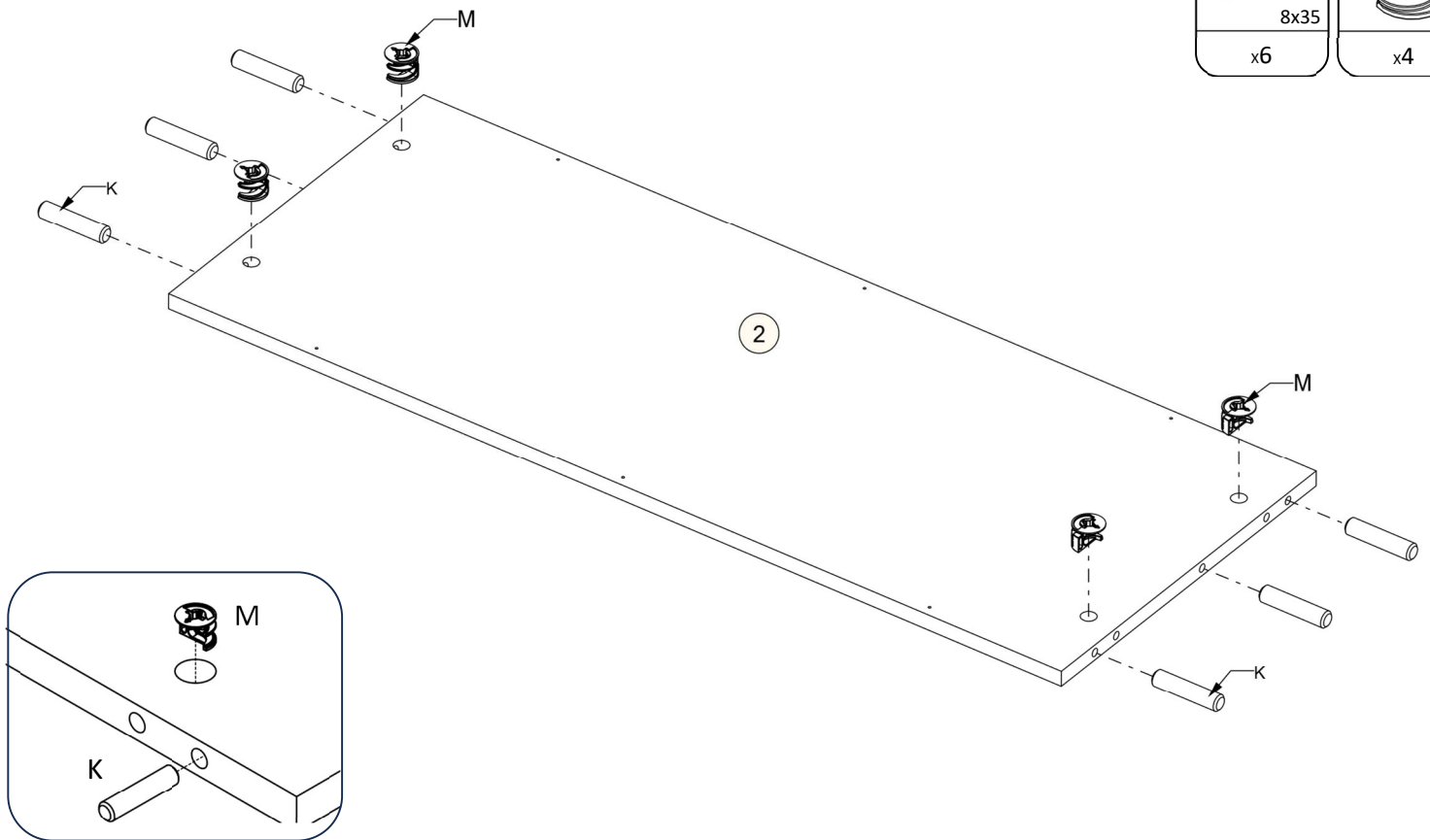
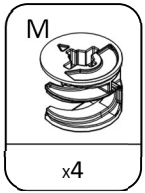
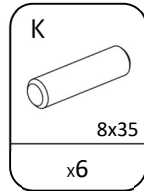

3

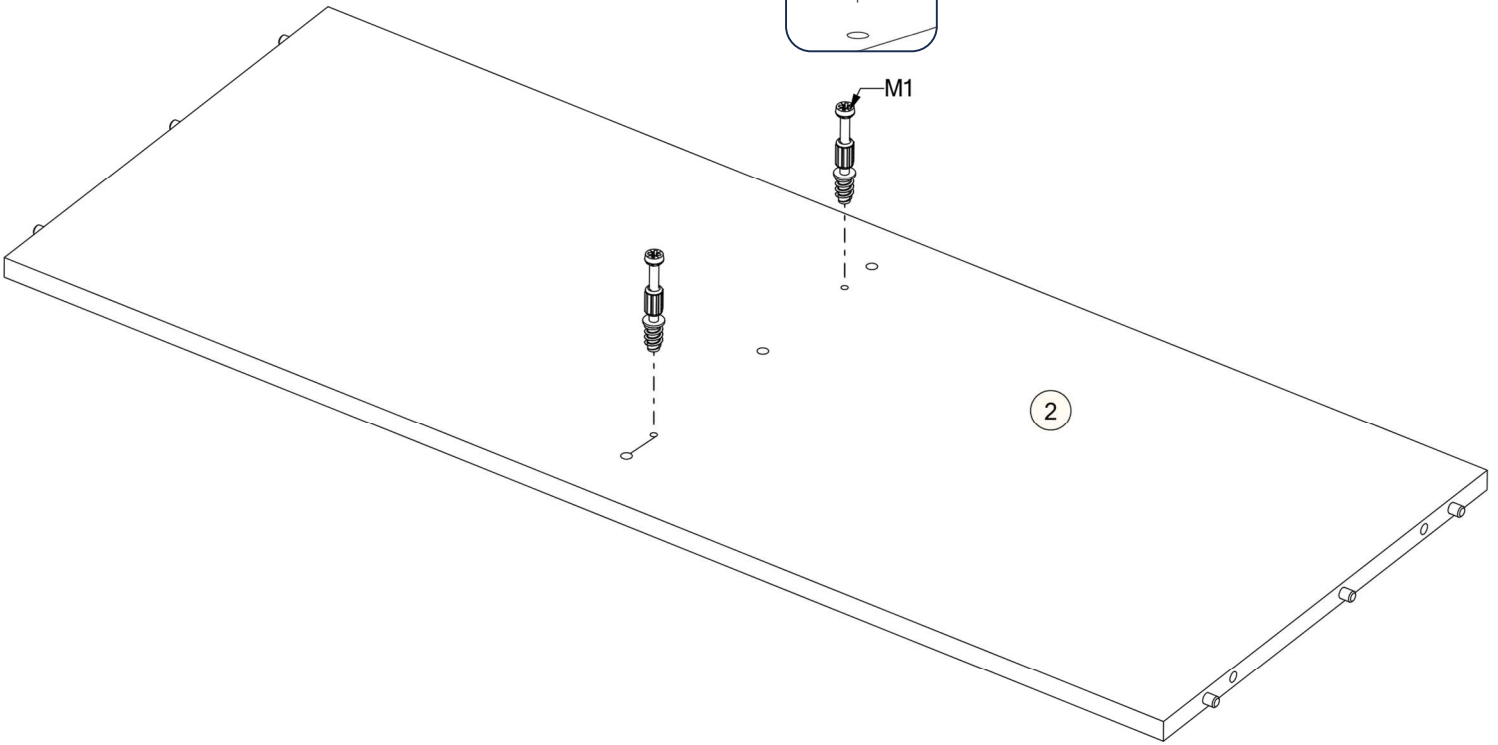
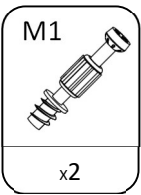
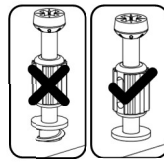
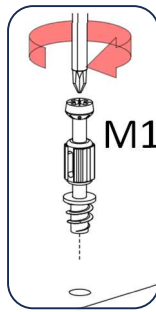

4

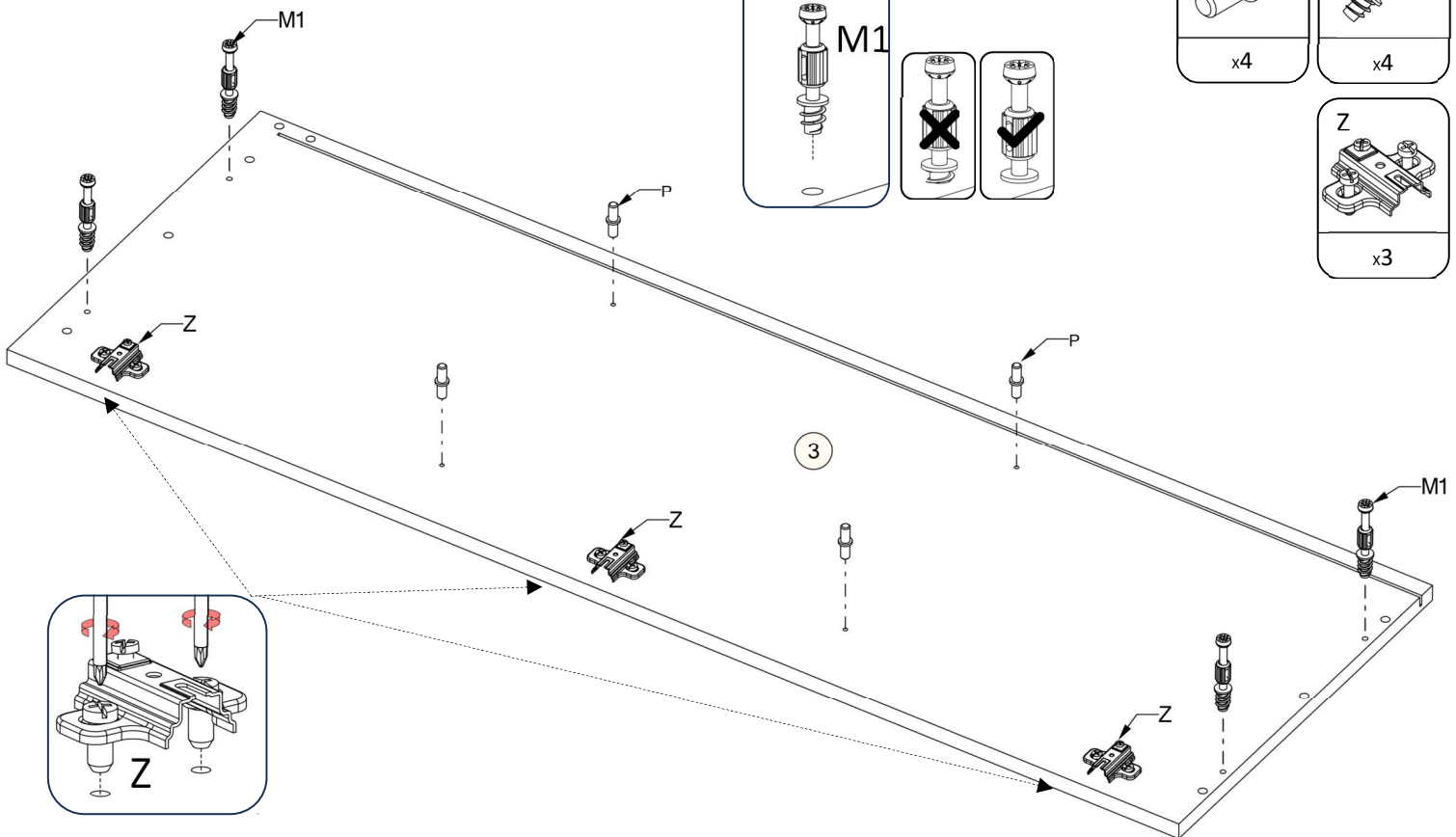
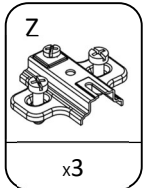
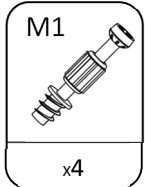
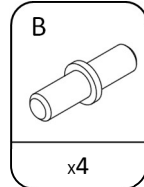
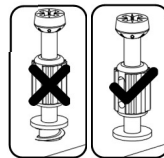
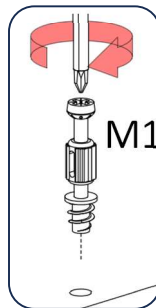

5

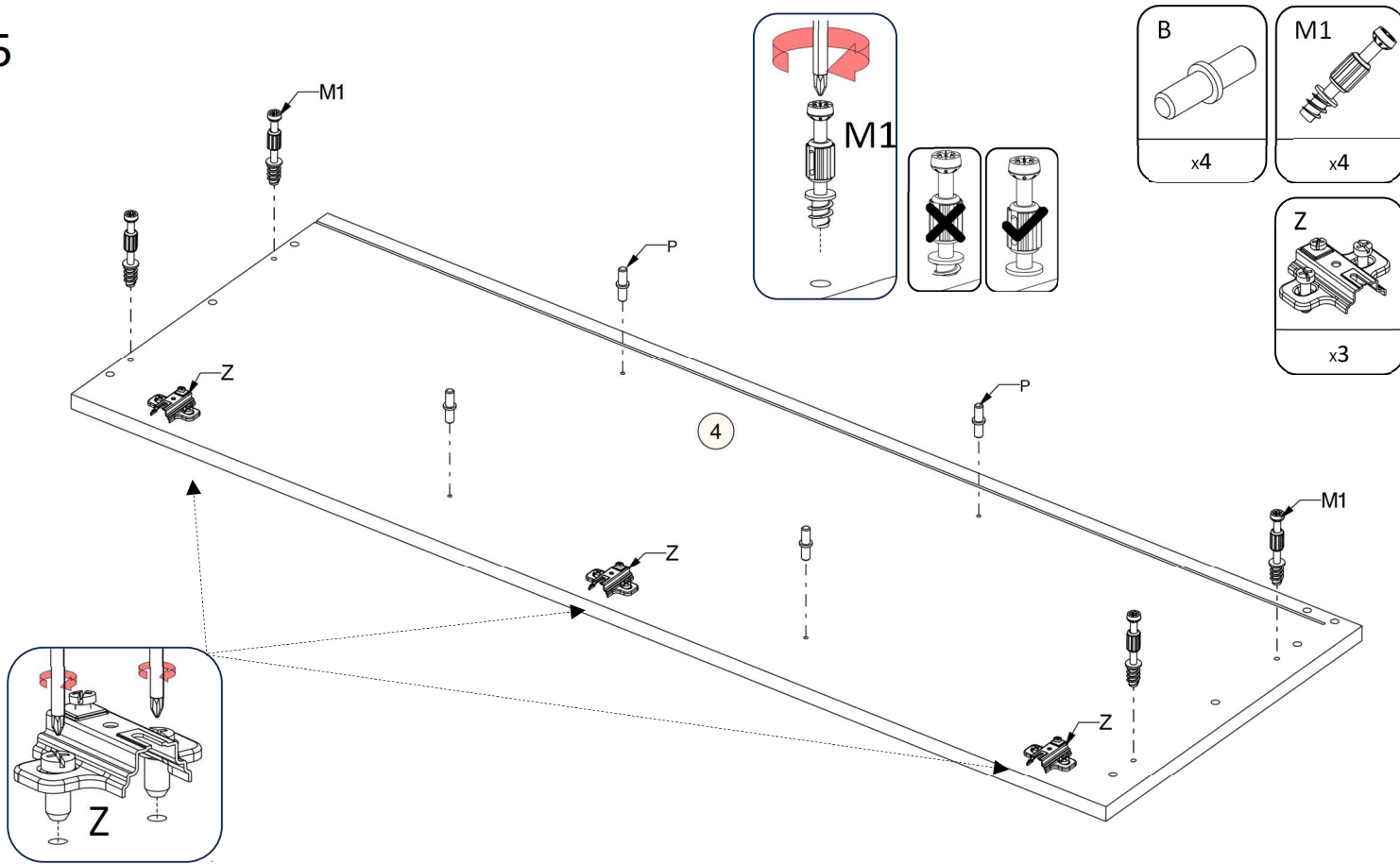

6

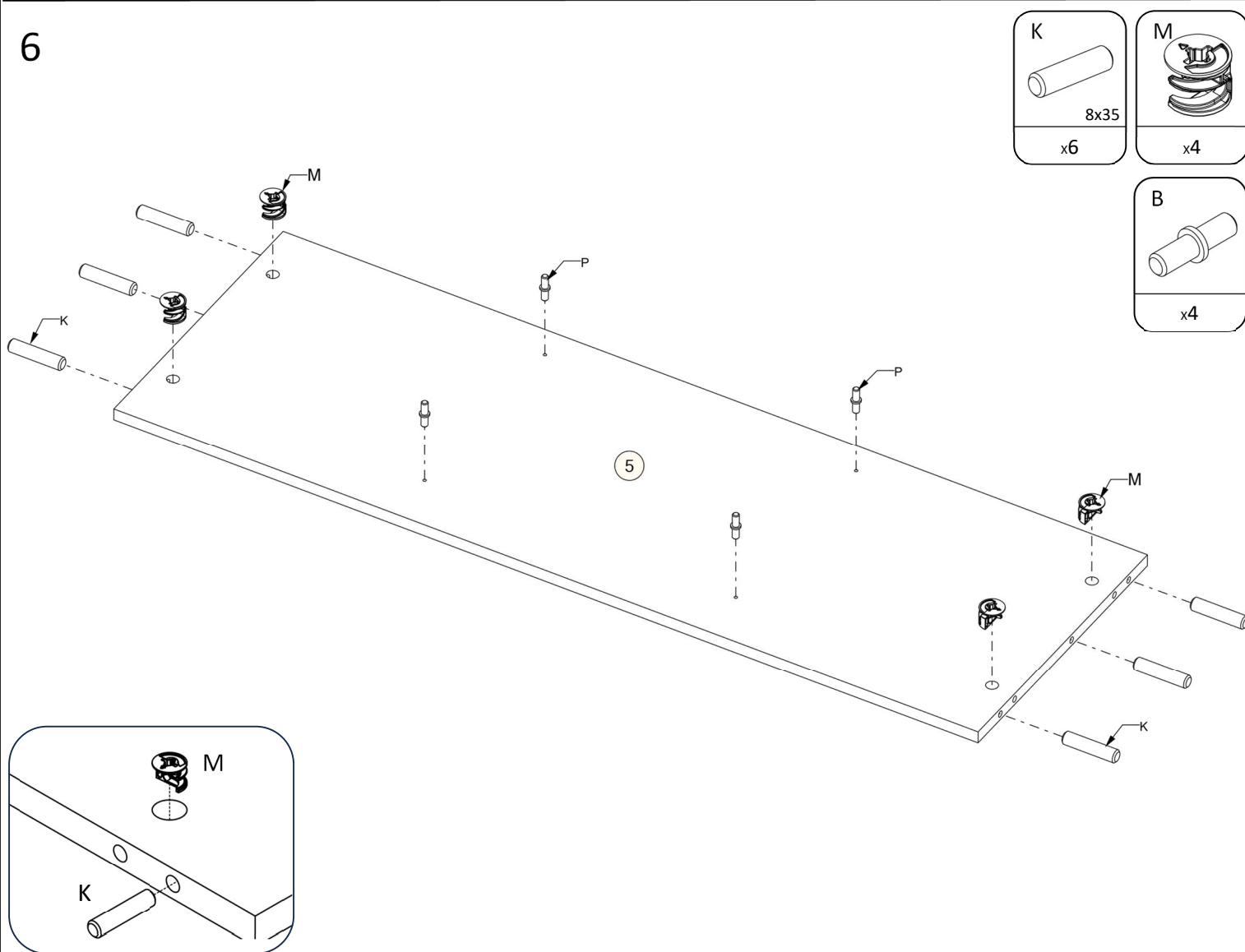

7

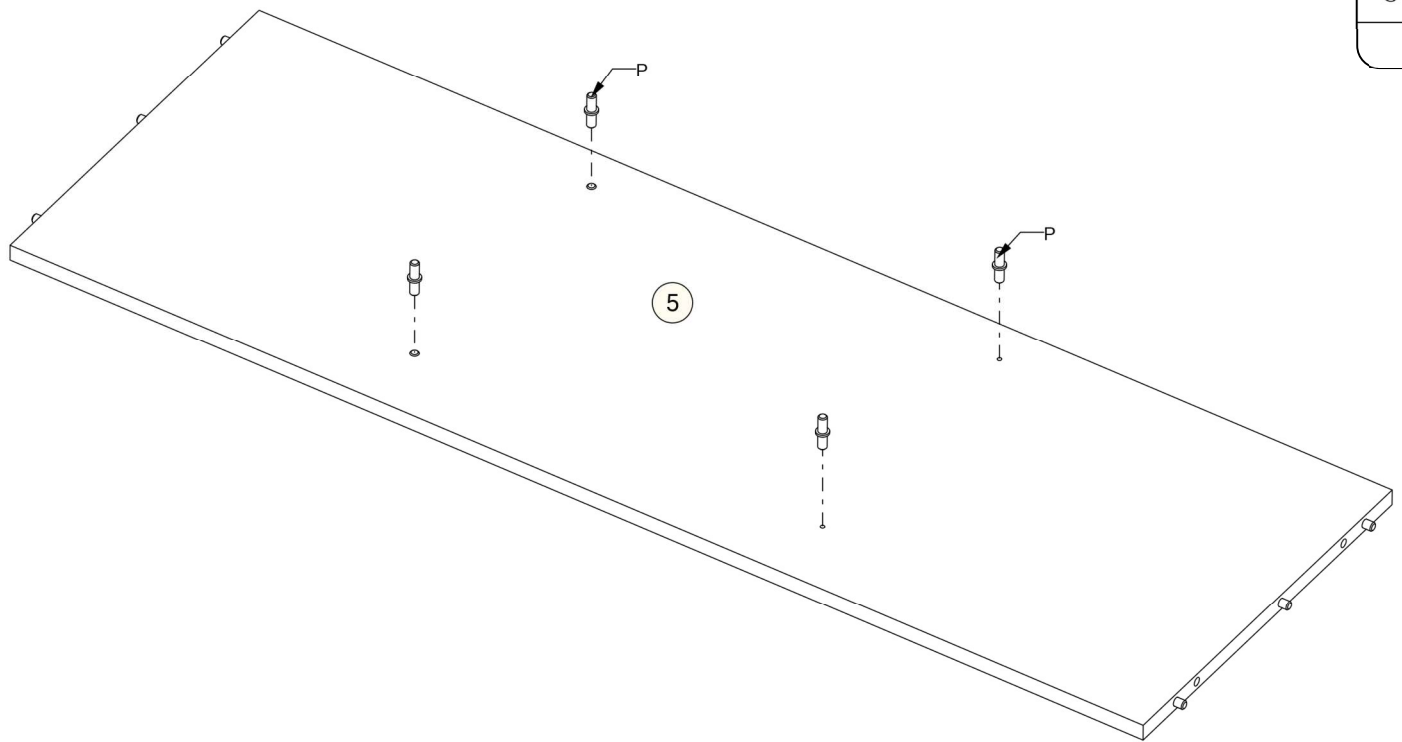

B

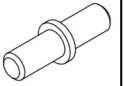

x4

8

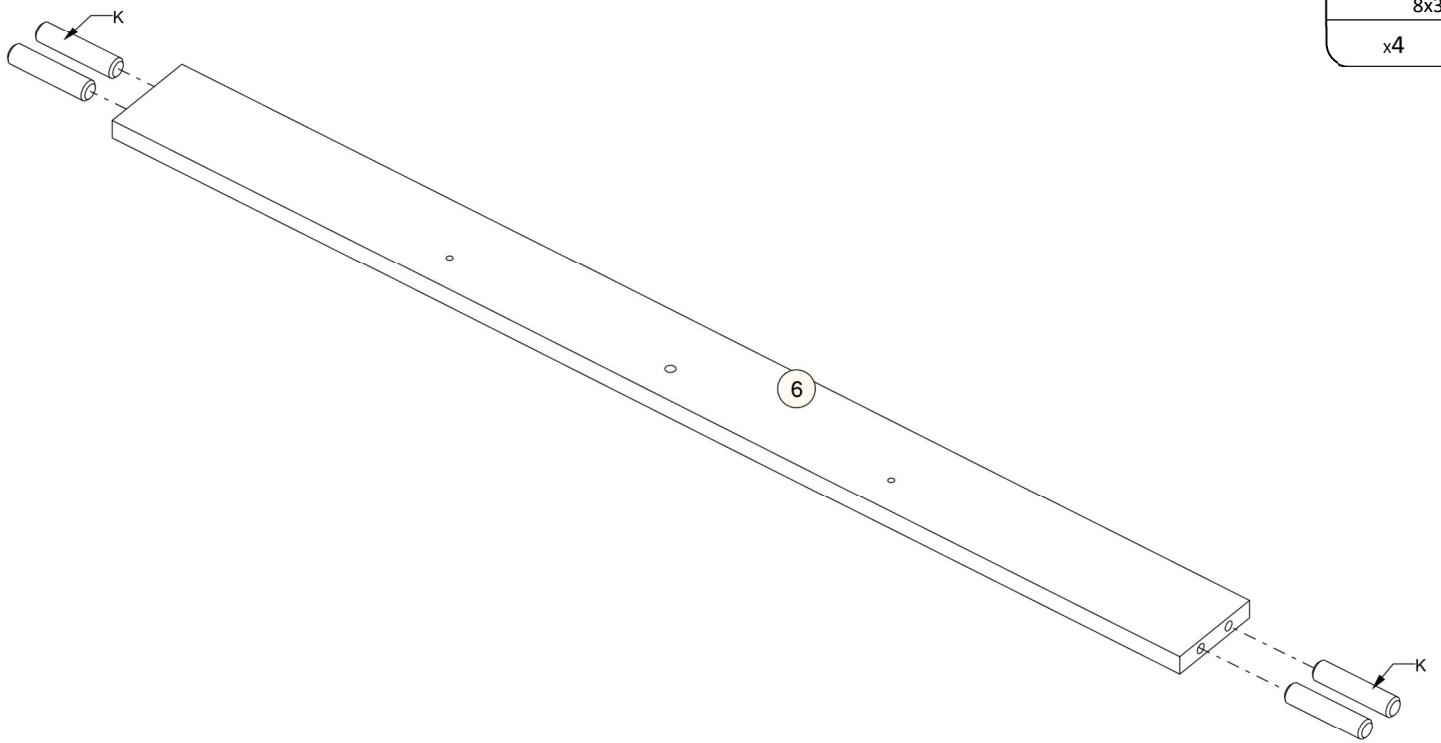

K

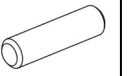

8x35

x4

9

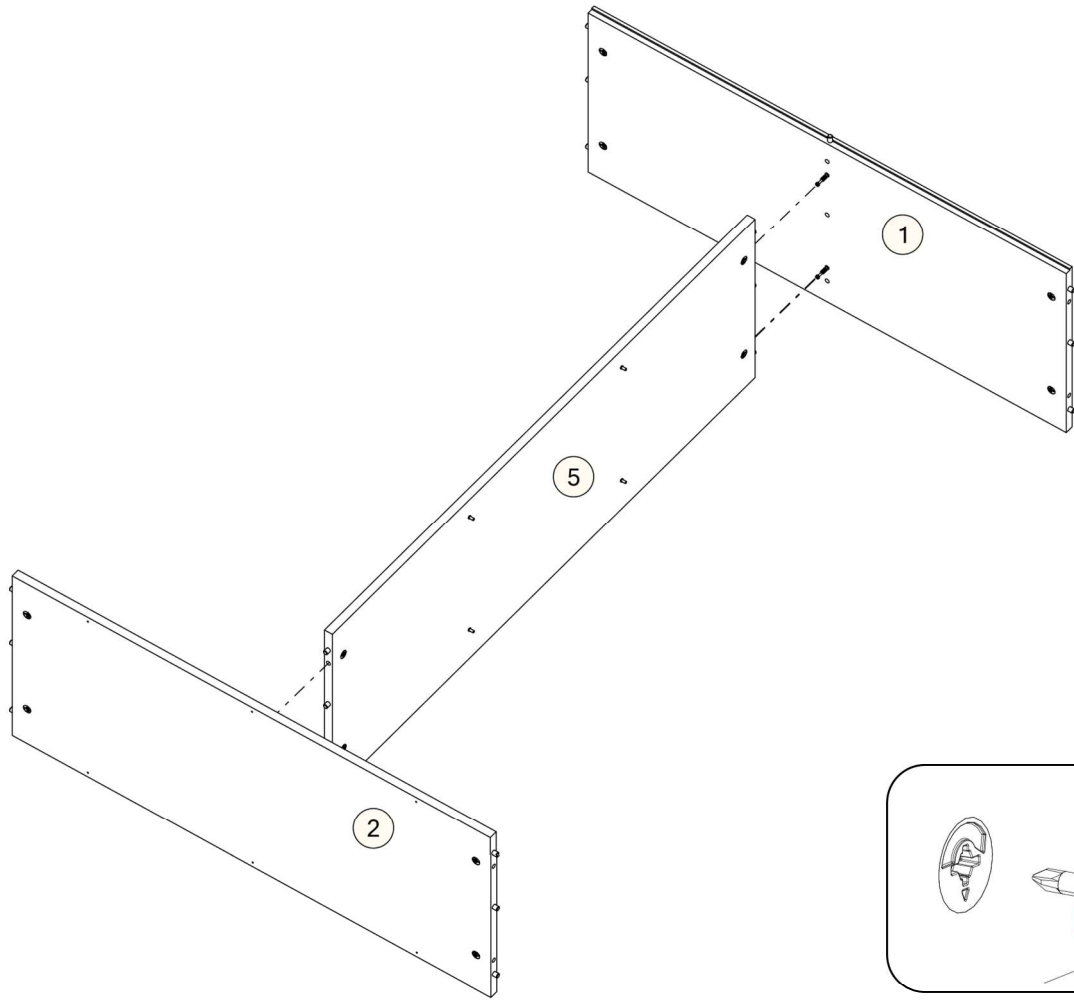

10

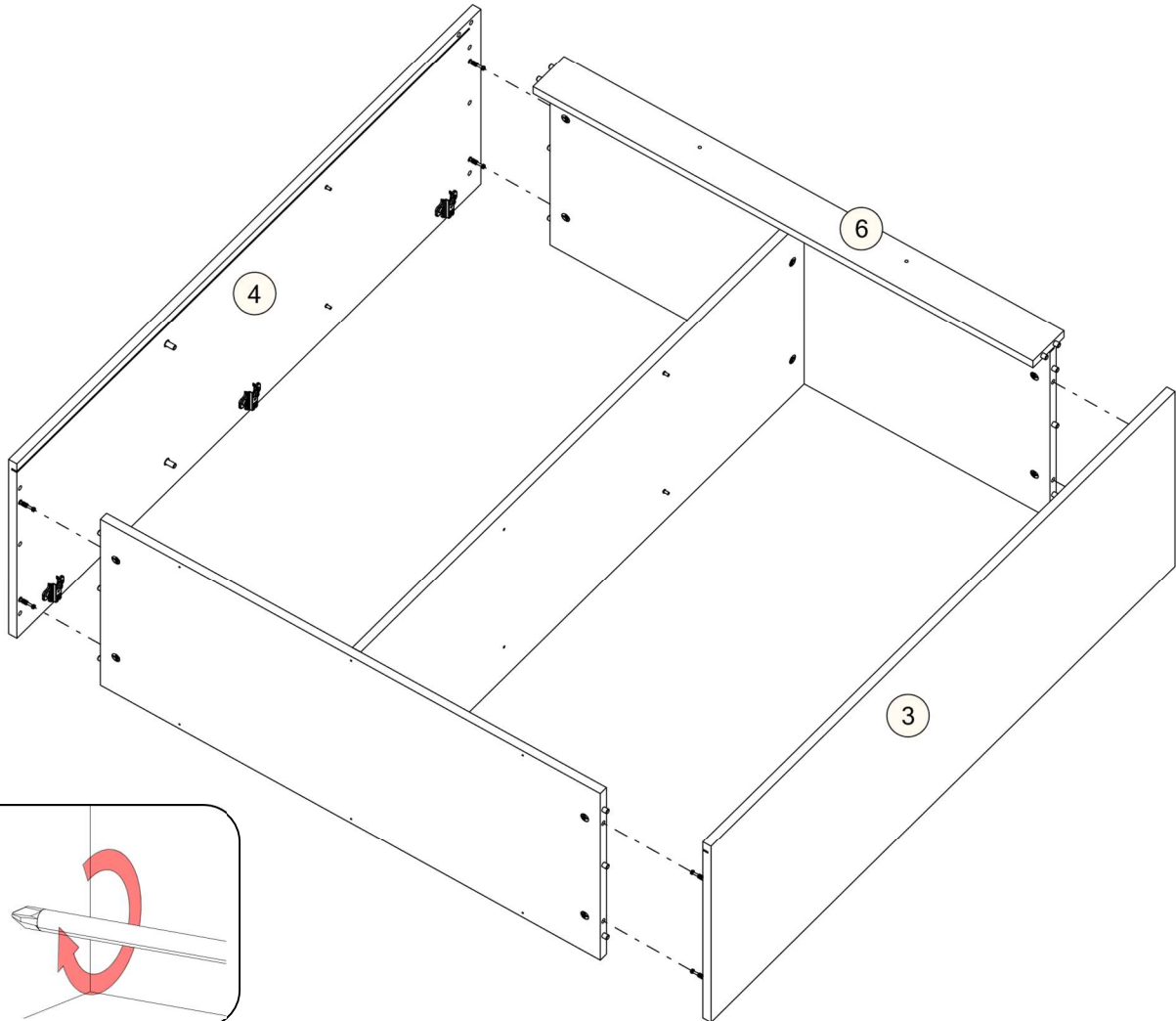

11

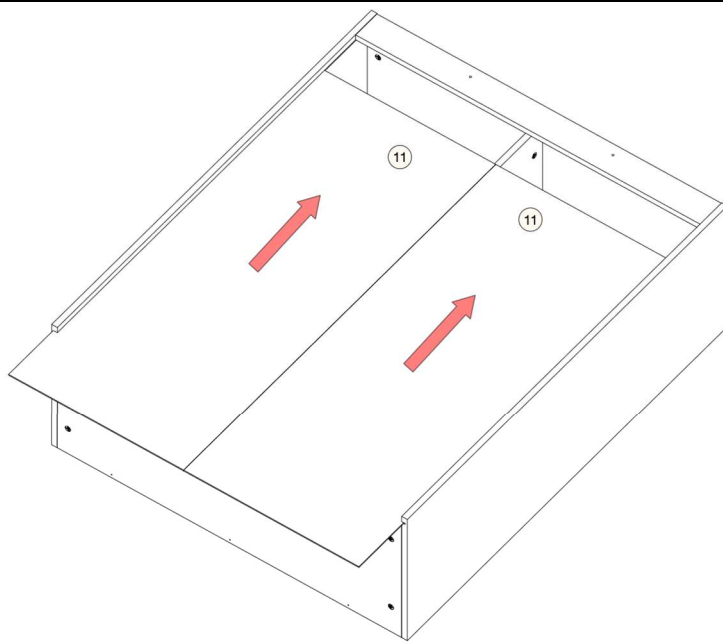

12

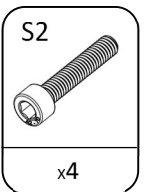
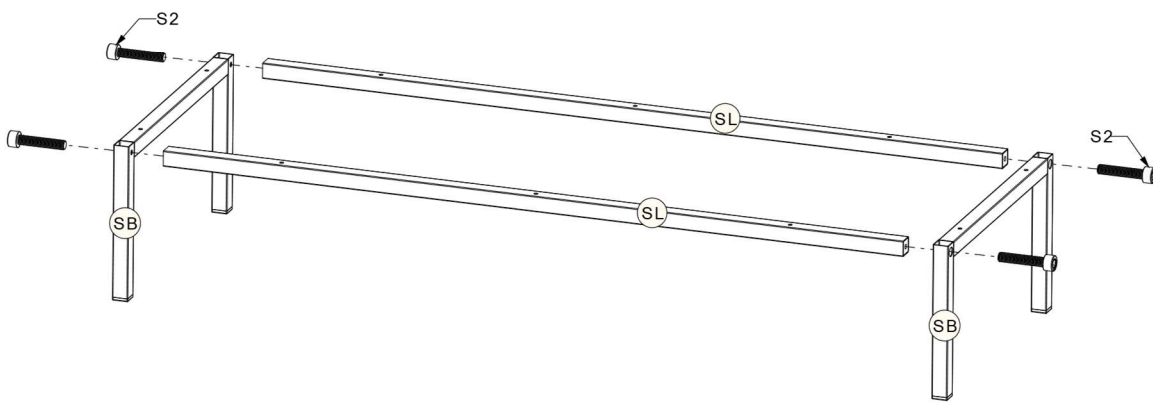

13

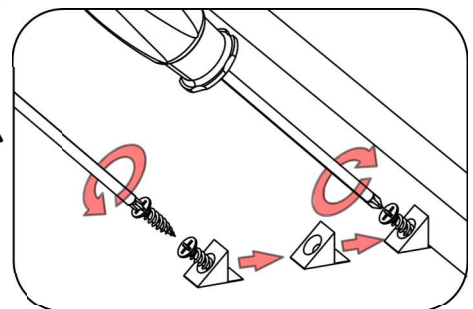
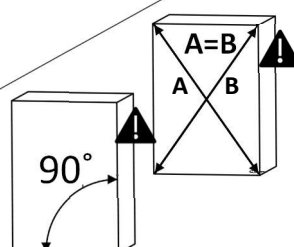
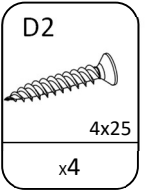
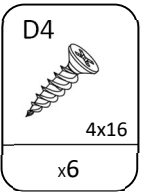
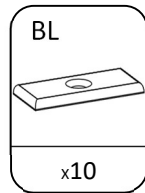
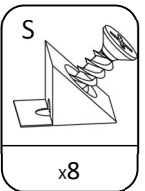
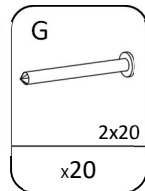
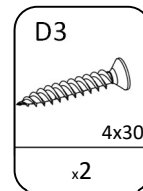
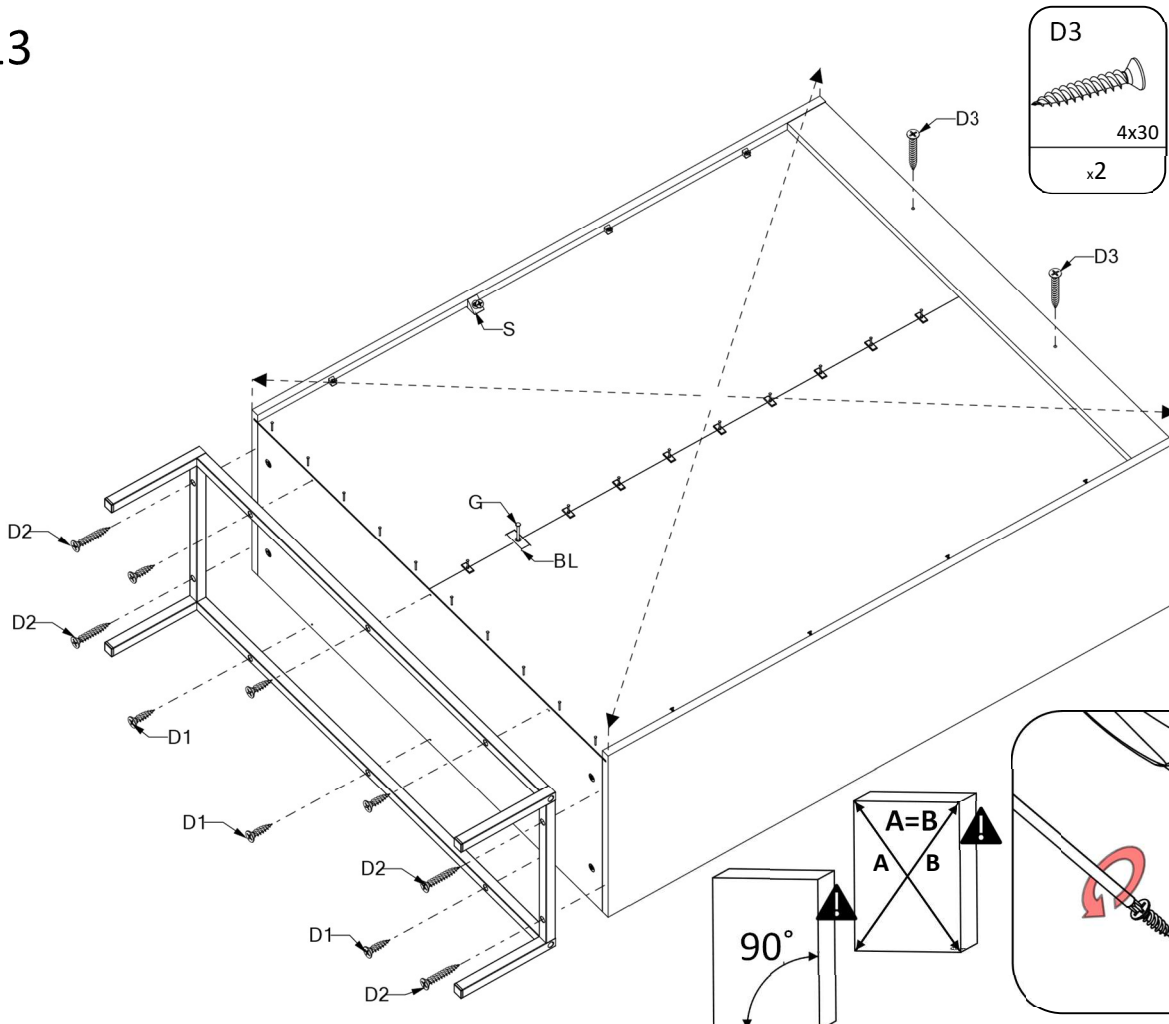

14

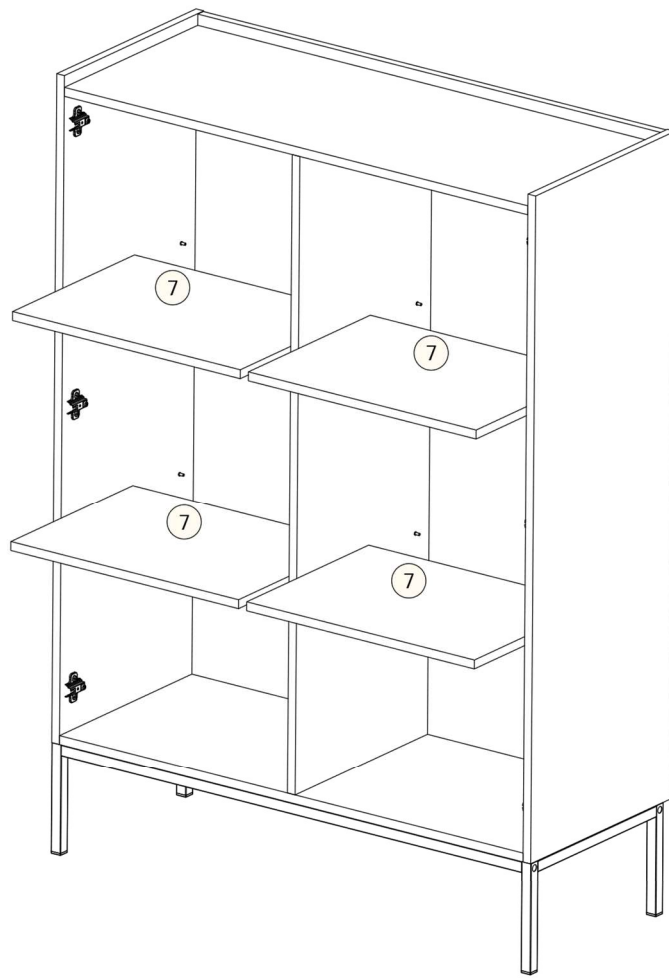

15

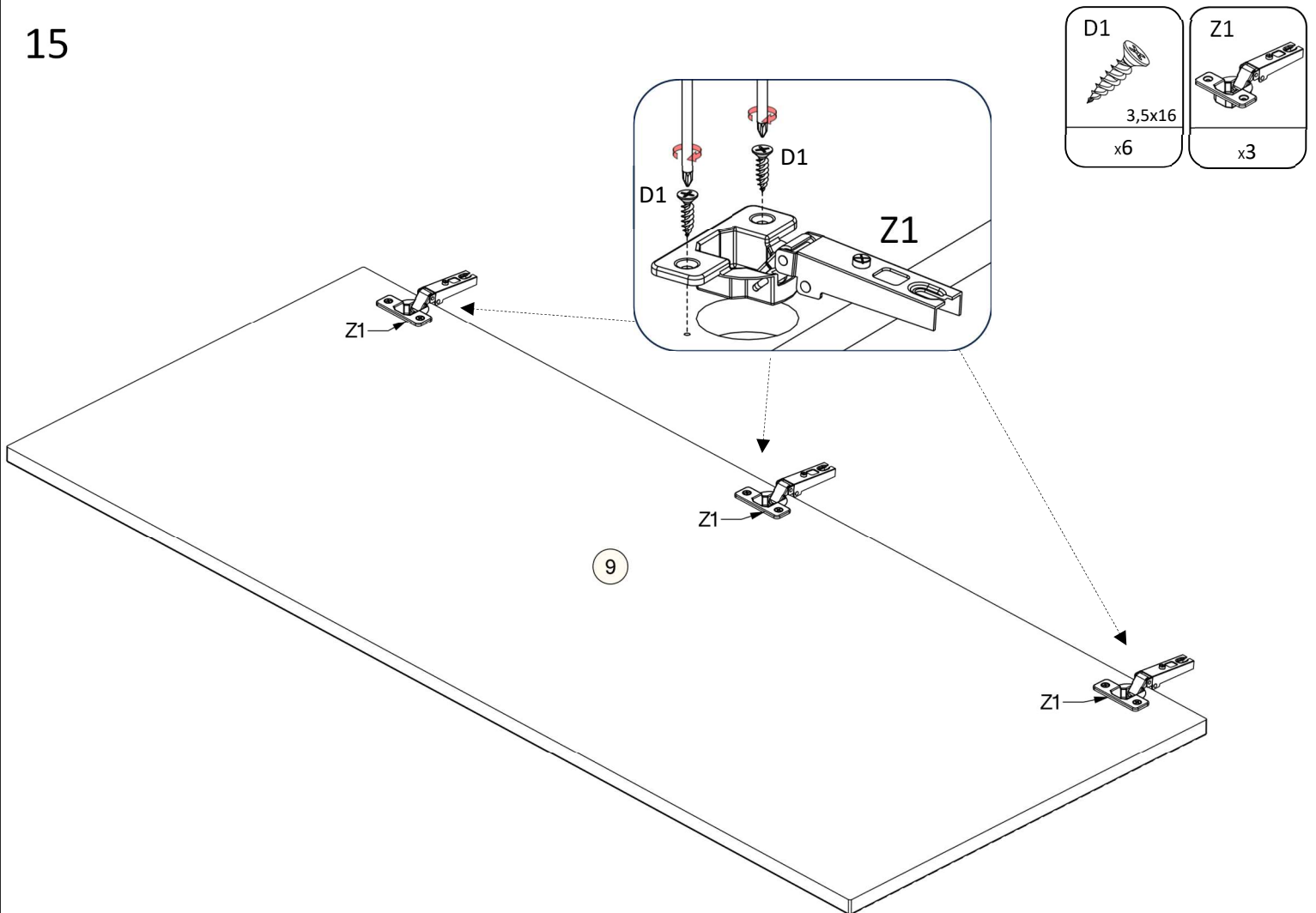

16

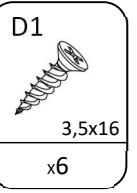
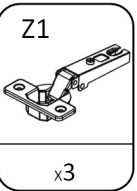
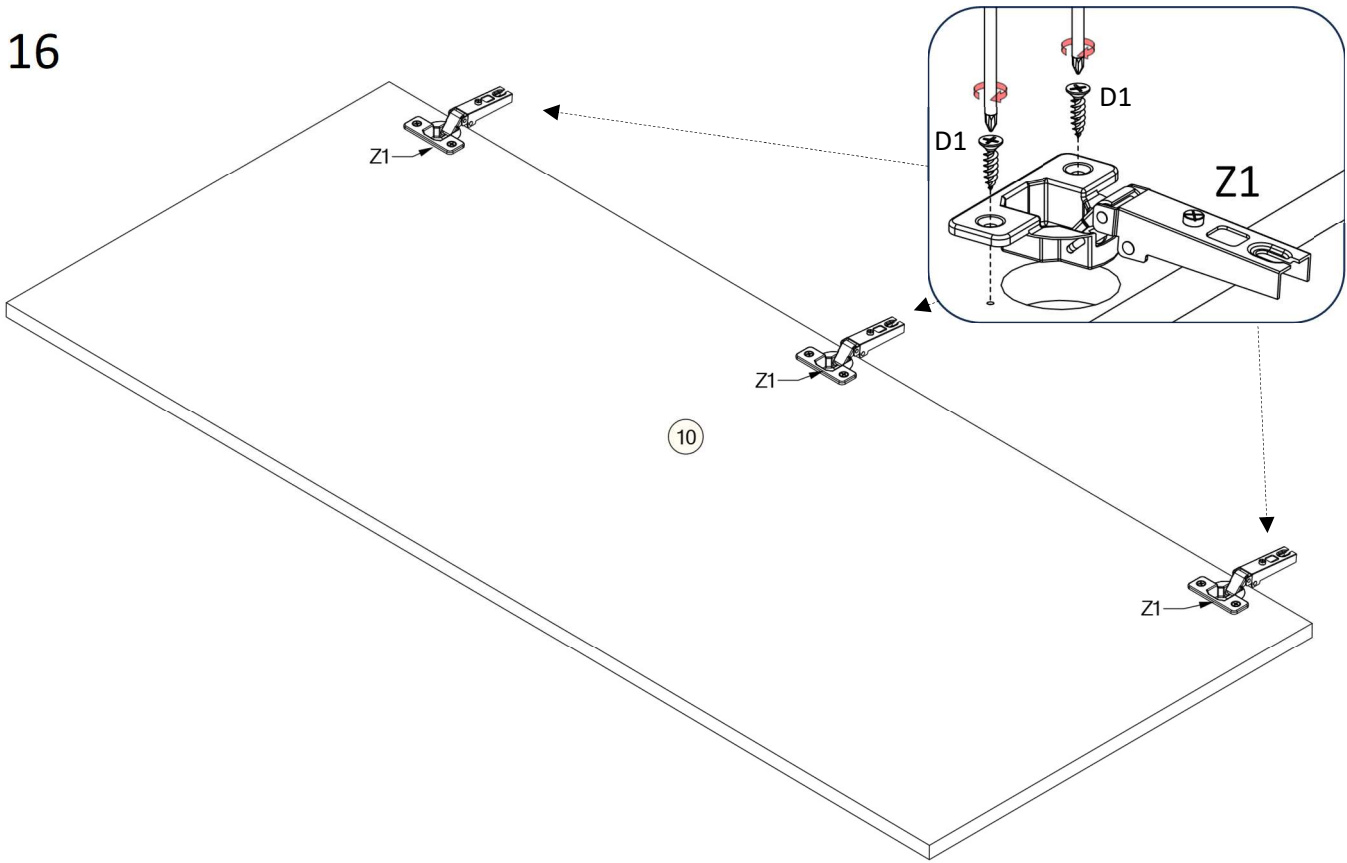

17

